

Cupido

irresistibile

Pascal

il cuore ha le sue ragioni che la ragione non conosce

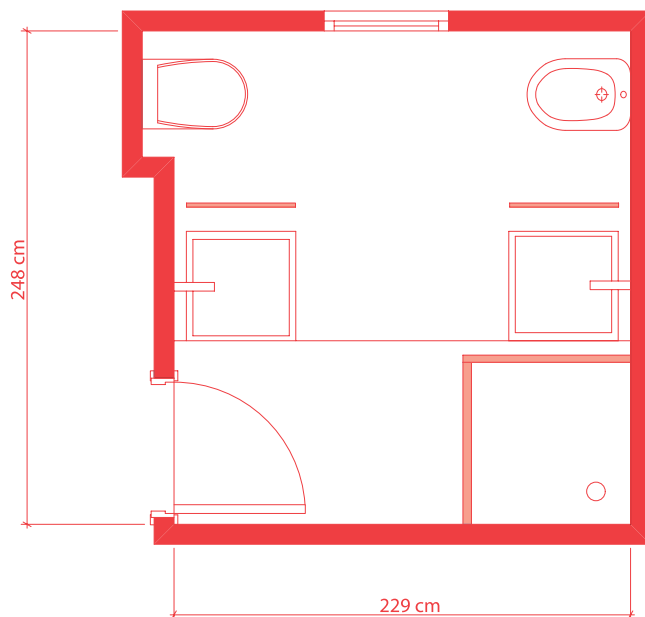

il tuo bagno, la tua casa



Wall:
Cupido Rosso 30,5x91,5 RT
Cupido Bianco 30,5x91,5 RT
Emozione rombi colore inserto mix 2 61x91,5 RT

Floor:
For love metal Argento 30,5x30,5 RT

Project on page 64





Musil

Il linguaggio dell'amore è un linguaggio segreto e la sua espressione più alta è un abbraccio silenzioso

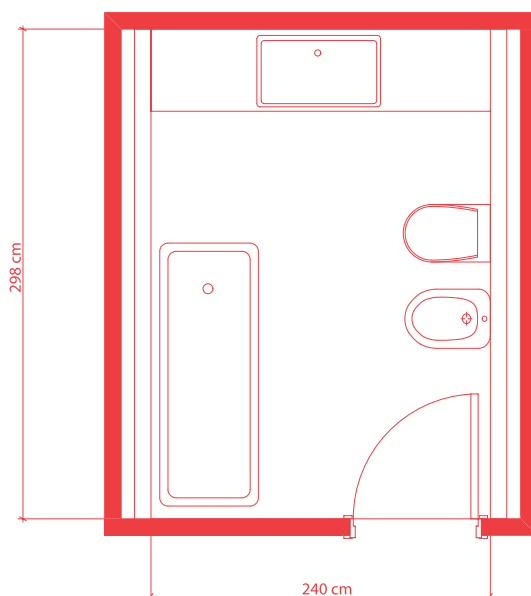

il tuo bagno, la tua casa

The language of love is a secret language and its highest expression is a quiet embrace. **Die Sprache** der Liebe ist eine Geheimsprache und ihr höchster Ausdruck ist eine stille Umarmung. **Le langage** de l'amour est un langage secret et c'est pour l'exprimer au mieux qu'on s'enlace en silence. **El lenguaje** del amor es un lenguaje secreto y su mayor expresión es un abrazo silencioso. **Язык любви** сокрыт секретом, а его наивысшее выражение - молчаливое объятие.



Wall:
Cupido Mandorla 30,5x91,5 RT
Cupido Tortora 30,5x91,5 RT
Gelosia Mandorla inserto 30,5x91,5 RT

Floor:
Cupido Tortora 30,5x30,5 RT

Project on page 65



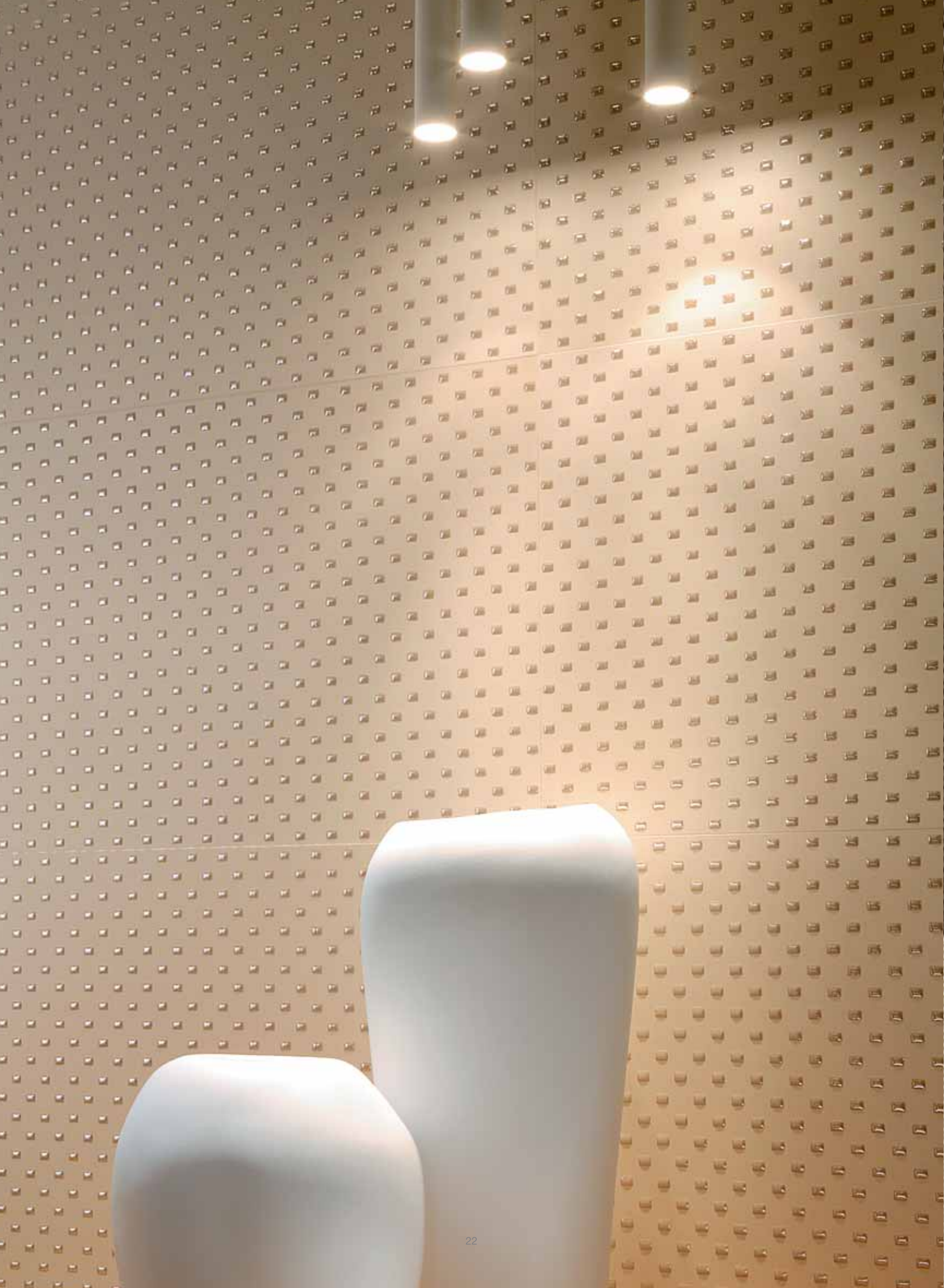



Bechov

quando ami, scopri in te una tale ricchezza, da non credere nemmeno di saper tanto amare

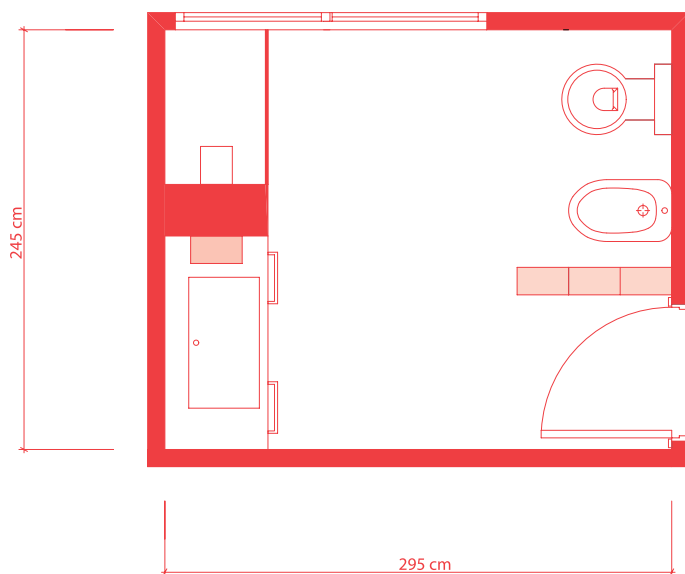

il tuo bagno, la tua casa

When you love, you discover in yourself such wealth, such sweetness, such affection, as to not even believe you could love so much. **Wenn** du liebst, dann entdeckst du in dir einen solchen Reichtum, dass du es nicht einmal glauben willst, dass du so sehr lieben kannst. **Quand** vous aimez, vous découvrez une telle richesse en vous, que vous n'auriez jamais cru pouvoir tant aimer. **Cuando** amas, descubres en ti tanta riqueza, que ni siquiera creías que sabías amar tanto. **Когда любишь, открываешь в себе такое богатство, что даже не верится, что можешь так любить.**





Wall:
Cupido Gemma 30,5x91,5 RT
Cupido Gemma mosaico 30,5x30,5
Amore Gemma inserto 30,5x91,5 RT

Floor:
Cupido Gemma 30,5x30,5 RT

Project on page 66





Beethoven

l'amore chiede tutto, ed ha diritto di farlo.

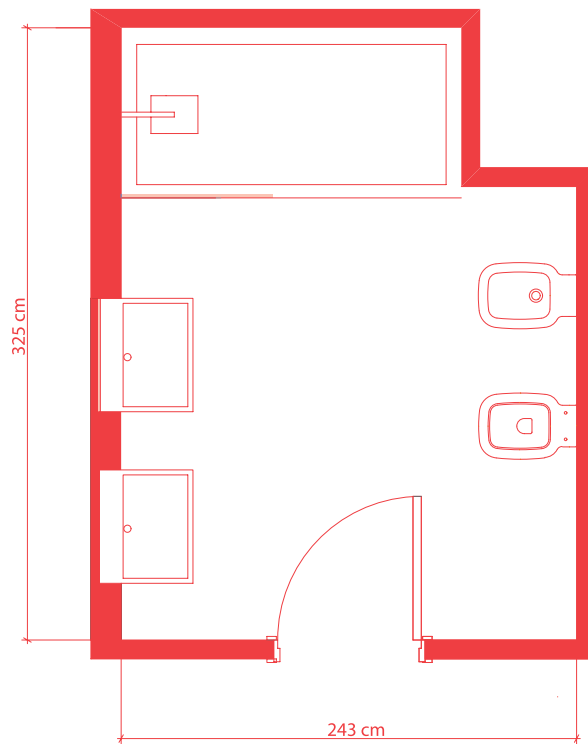

il tuo bagno, la tua casa

Love demands all, and has the right to do so. Die Liebe fordert alles und das mit Recht. L'amour exige tout, et il a le droit de le faire. El amor exige todo, y tiene derecho a hacerlo. Любовь требует всего, и она имеет на это право.





Wall:
Cupido Perla 30,5x91,5 RT
Opera Lavagna inserto mix 3 91,5x91,5 RT
Variazione Nero listello A 4x30,5 RT
Variazione Nero listello B 4x30,5 RT

Floor:
Cupido Perla 30,5x30,5 RT

Project on page 67



Flesse

l'amore non vuole possedere nulla, vuole solo amare

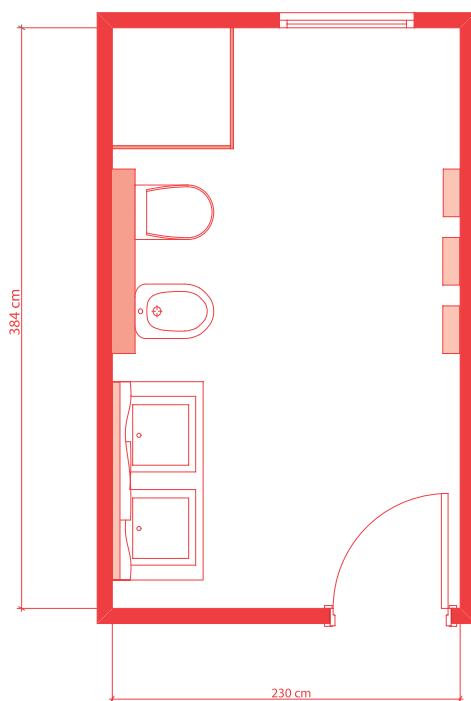

il tuo bagno, la tua casa





Wall:
Cupido Cipria 30,5x91,5 RT
Cupido Tortora 30,5x91,5 RT
Opera Rosa inserto mix 3 91,5x91,5 RT
Cupido Tortora mosaico 30,5x30,5

Floor:
Cupido Tortora 30,5x30,5 RT

Project on page 68



Pound

il pensare divide il sentire unisce

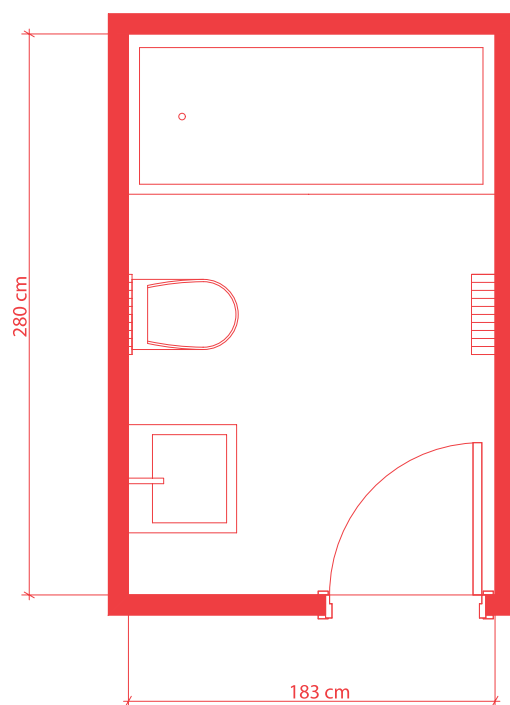

il tuo bagno, la tua casa

Thinking divides, feeling unites. **Gedanken** trennen, Gefühle vereinen. **Penser** éloigne les êtres, ressentir les unit. **El pensar** separa, el sentir une. **Мысли** разъединяют, чувства объединяют.



Wall:
Cupido Bianco mosaico 30,5x30,5
Cupido Celeste 30,5x91,5 RT
Variazione Bianco listello A 4x30,5 RT
Variazione Bianco listello B 4x30,5 RT

Floor:
Cupido Celeste 30,5x30,5 RT

Project on page 69





Dickinson

che l'amore è tutto, è tutto ciò che sappiamo dell'amore

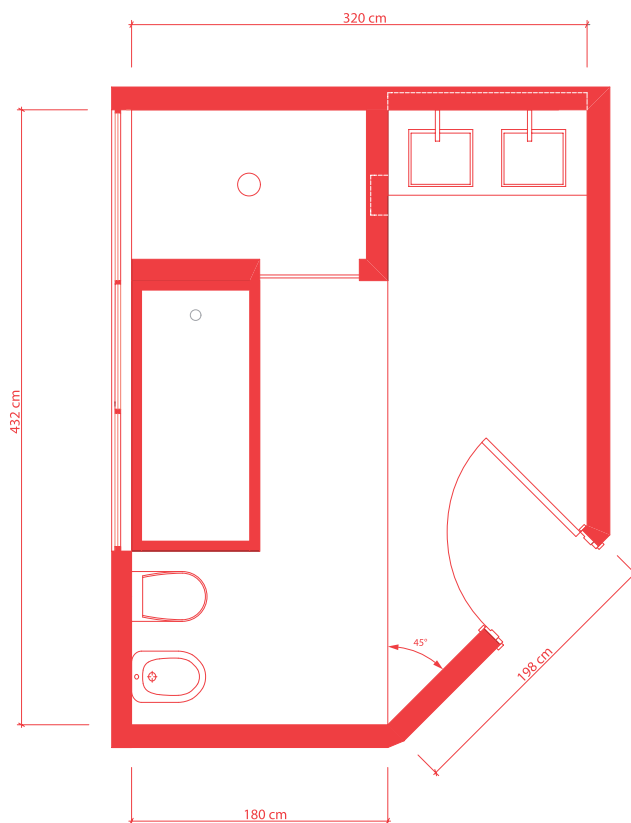

il tuo bagno, la tua casa

That Love is all there is, **Is** all we know of Love. **Die Liebe** ist alles, sie ist alles, was wir über die Liebe wissen. **Que l'amour** est tout, c'est tout ce que nous savons de l'amour. **Todo** lo que sabemos del amor es que el amor lo es todo. **Любовь** – это все, и это все, что мы о ней знаем.





Wall:

Cupido Tortora 30,5x91,5 RT
Cupido Mandorla mosaico 30,5x30,5
Emozione Mandorla rombi inserto mix 2 61x91,5 RT
Emozione Mandorla fiori inserto mix 2 61x91,5 RT
Emozione Mandorla righe inserto mix 2 61x91,5 RT

Floor:

Cupido Tortora 30,5x30,5 RT
Cupido Mandorla 30,5x30,5 RT

Project on page 70





Shakespeare

l'amore guarda non con gli occhi ma con l'anima

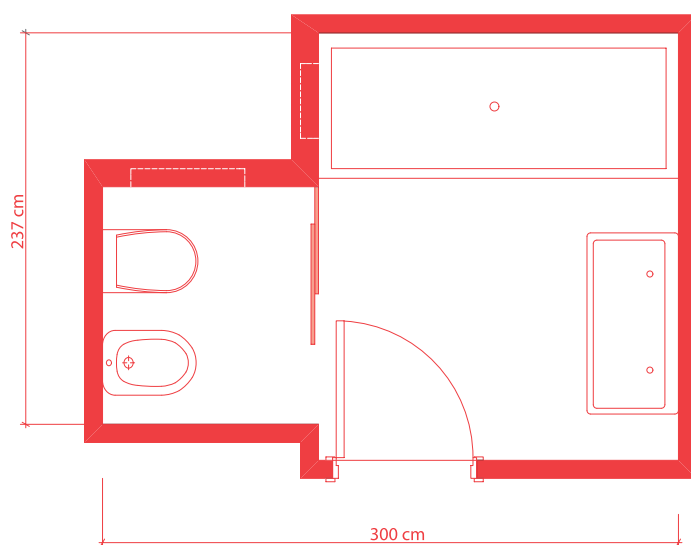

il tuo bagno, la tua casa

Love looks not with the eyes, but with the mind. Die Liebe sieht nicht mit den Augen, sondern mit der Seele. L'amour ne regarde pas avec les yeux mais avec l'âme. El amor no mira con los ojos sino con el alma. Любовь смотрит не глазами, а сердцем.



Wall:
Cupido Lavagna 30,5x91,5 RT
Cupido Rosso 30,5x91,5 RT
Cupido modern Nero mosaico 30,5x30,5
Cuore Rosso mosaico
Cuore Nero mosaico

Floor:
Cupido Lavagna 30,5x30,5 RT

Project on page 71





Jean-Michel Basquiat Show



**La ceramica si fluidifica creando volumi, movimenti, emozioni.
Forme ed elementi emergono con esuberanza dallo spazio, inventando suggestivi incontri di luce.
È Fap+. Struttura e decoro. Funzionalità e design. Razionalità ed emozione.
In equilibrio perfetto.**

Ed ora Fap+ presenta VARIAZIONE+ la prima linea di oggetti ed accessori, per dare al tuo bagno una personalità inconfondibile.

Ceramics flow to create forms, movement and excitement.
Pieces and shapes emerge dynamically, inventing beautiful interactions of light.
Fap+. Structure and decoration. Functionality and design. Rationality and passion. In perfect balance.
Fap+ is now introducing VARIAZIONE+, its first line of accessories and objects, giving your bathroom unmistakable personality.

Keramik verflüssigt sich und schafft Volumen, Bewegungen, Emotionen.
Formen und Elemente werden zum Blickfang im Raum und schaffen eindrucksvolle Lichtbegegnungen.
Das ist Fap+. Struktur und Dekor Funktionalität und Design: Stimmungsvolle Zweckmäßigkeit. Mit perfekter Ausgewogenheit.
Und jetzt präsentiert Fap+ VARIAZIONE+: die erste Linie mit einer Auswahl an Objekten und Accessoires, um Ihrem Bad einen unvergleichlichen Charakter zu verleihen.

La céramique se fluidifie en créant des volumes, des mouvements, des émotions.
Les formes et les éléments surgissent de l'espace avec exubérance, composant de suggestives rencontres de lumière.
C'est Fap+. A la fois structure et décor. Fonctionnalité et design. Raison et émotion. Dans un équilibre idéal.
Et maintenant, Fap+ présente VARIAZIONE+ la première ligne d'objets et d'accessoires, pour donner à votre salle de bains une personnalité incomparable.

La cerámica se fluidifica creando volúmenes, movimientos y emociones.
Formas y elementos emergen del espacio con vivacidad, inventando sugestivos encuentros de luz.
Es Fap+. Estructura y decoración. Funcionalidad y diseño. Racionalidad y emoción. En perfecto equilibrio.
Y ahora Fap+ presenta VARIAZIONE+, la primera línea de objetos y accesorios, para conferir a tu cuarto de baño una personalidad inconfundible.

Керамика становится пластичной, создавая объемы, движения, эмоции.
Формы и элементы энергично выступают из пространства, создавая впечатляющие световые эффекты.
Это Fap+. Структура и декор, функциональность и дизайн, рациональность и эмоции в безупречном равновесии.
Теперь Fap+ представляет VARIAZIONE+ - первую линию предметов и аксессуаров, которые дадут вашей ванной комнате неповторимую индивидуальность.

VARIAZIONE+

In una dinamica evoluzione, VARIAZIONE+ prende forma.

VARIAZIONE+ takes shape in dynamic evolution. / Eine dynamische Evolution, mit der VARIAZIONE+ Form annimmt.
Dans une évolution empreinte de dynamisme, VARIAZIONE+ prend forme. / En una dinámica evolución, toma forma
VARIAZIONE+. / Динамично развиваясь, VARIAZIONE+ принимает форму.

Sinuosa, mutevole, discreta ed estremamente elegante. La prima collezione del progetto FAP+ porta la firma della designer Angelika Mörlein.

Sinuous, whimsical, unobtrusive and extremely elegant. The first collection from the FAP+ project bears the signature of designer Angelika Mörlein. / Gewundene Formen, wandelbar, dezent und äußerst elegant. Die erste Kollektion des Projekts FAP+ trägt die Handschrift der Designerin Angelika Mörlein. / Sinueuse, changeante, discrète et très élégante. La première collection du projet FAP+ porte la signature de la designer Angelika Mörlein. / Sinuosa, dinámica, discreta y sumamente elegante. La primera colección del proyecto FAP+ lleva la firma de la diseñadora Angelika Mörlein. / Гибкая, переменчивая, сдержанная и в высшей степени элегантная. Первая коллекция проекта FAP+ выходит за подписью дизайнера Angelika Mörlein.



**mensola e accessori
la stanza si libera da oggetti superflui.**

the bathroom gets rid of unnecessary objects. / der Raum wird von überflüssigen Objekten befreit. / la pièce se libère de tout objet superflu. / la habitación se libera de objetos superfluos. / помещение освобождается от лишних предметов.

**attaccapanni
il lato utile della bellezza.**

the useful side of beauty. / die nützliche Seite der Schönheit. / le côté utile de la beauté. / el lado útil de la belleza. / полезная сторона красоты.



listello onda
vibrazioni di luce sulle pareti del bagno.

vibrant light for your bathroom walls. / vibrierende Lichtreflexe auf den Wänden Ihres Bads. / des vibrations de lumière sur les murs de votre salle de bains. / vibraciones de luz en las paredes del cuarto de baño. / переливы света на стенах ванной комнаты.



elemento modulare cubo
la componibilità è diventata arte.

modularity becomes an art form. / die Zusammenstellbarkeit ist zur Kunst geworden. / la modularité est désormais un art. / la modularidad hecha arte. компоновка стала искусством.

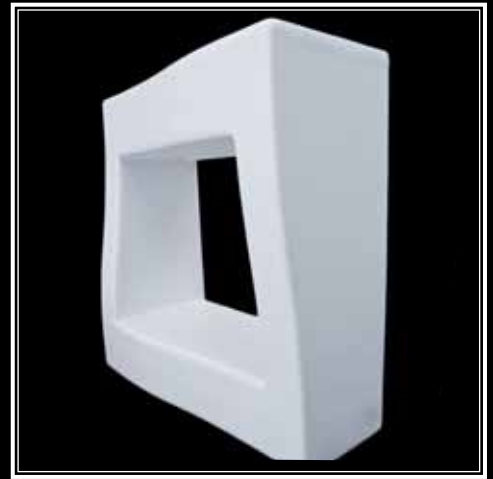

mensola cubo
forme seducenti per arredare lo spazio.

appealing shapes decorate your space. / verführerische Formen, um den Raum einzurichten. / des formes séduisantes pour aménager l'espace. / formas seductoras para decorar el espacio. / привлекательные формы для обстановки пространства.





Wall A

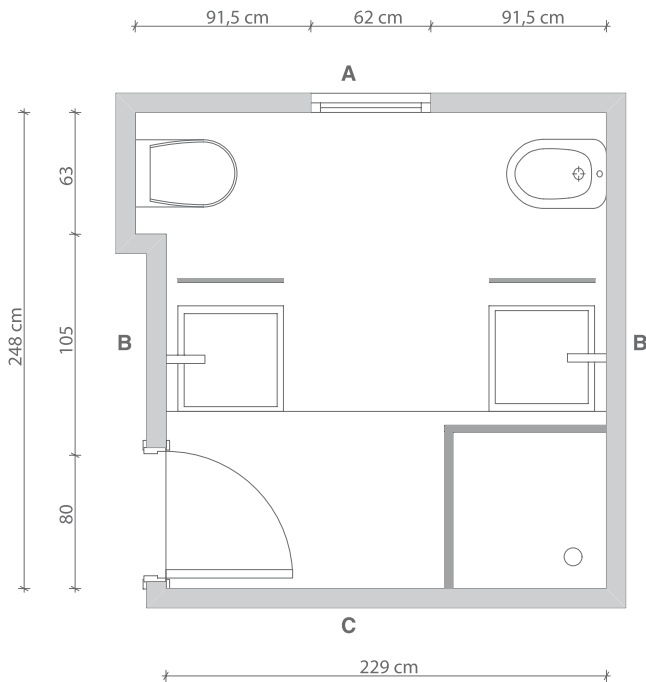
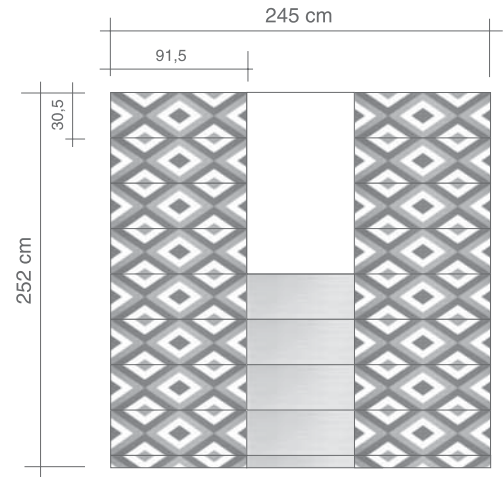

Wall B

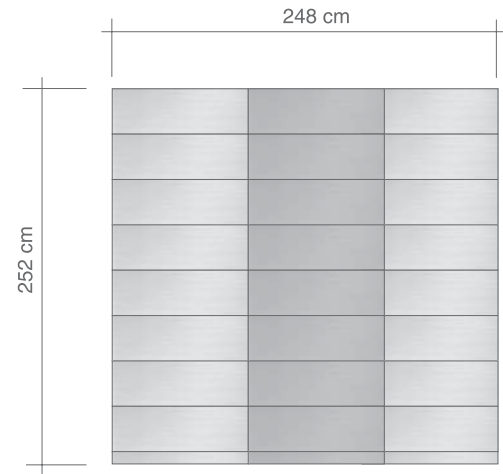

Wall C

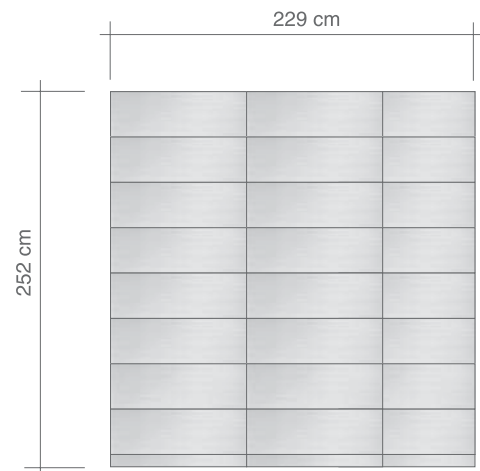

Wall A

Emozione rombi colore inserto
mix 2 61x91,5 RT
Cupido Bianco 30,5x91,5 RT

Wall B

Cupido Bianco 30,5x91,5 RT
Cupido Rosso 30,5x91,5 RT

Wall C

Cupido Bianco 30,5x91,5 RT

Floor

For love metal argento 30,5x30,5 RT

Stucco-Grout Wall

TonosuTono 01 Bianco
TonosuTono 18 Rosso

Stucco-Grout Floor

TonosuTono 12 Nero

Wall A

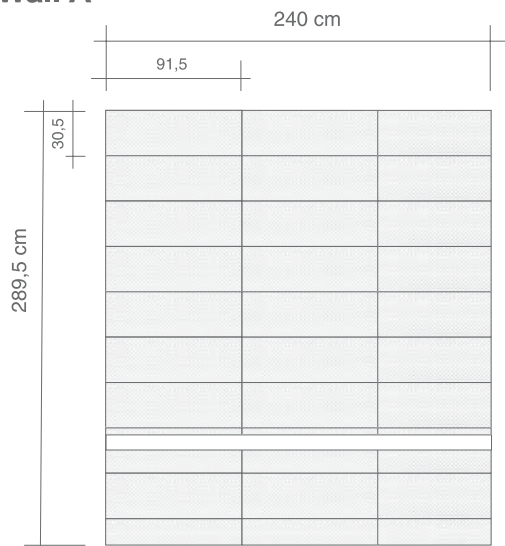

Wall B

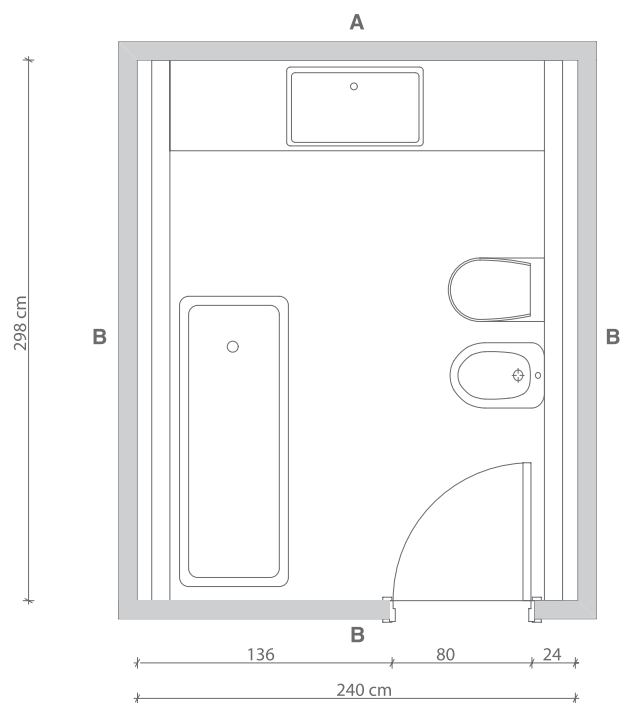
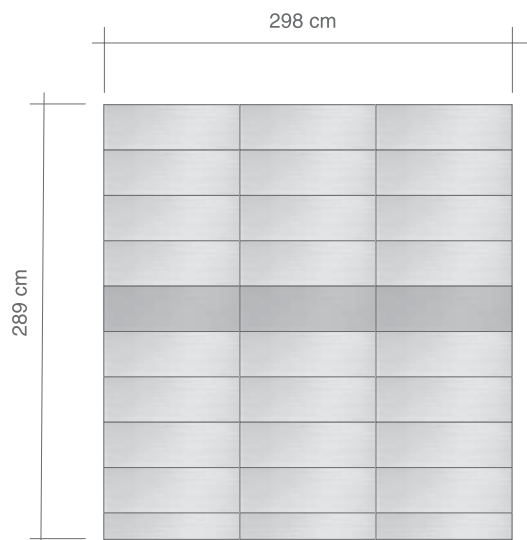

Wall A

Gelosia Mandorla inserto 30,5x91,5 RT

Wall B

Cupido Mandorla 30,5x91,5 RT
Cupido Tortora 30,5x91,5 RT

Floor

Cupido Tortora 30,5x30,5 RT

Stucco-Grout Wall

TonosuTono 15 Magnolia

Stucco-Grout Floor

TonosuTono 15 Magnolia



Wall A

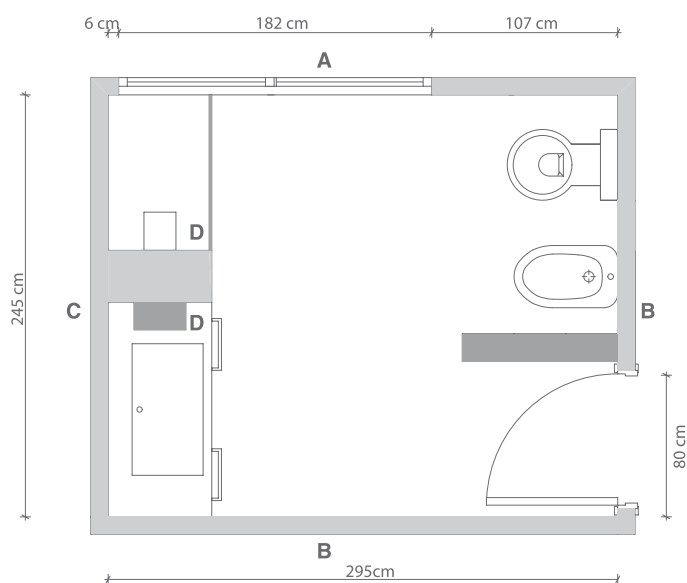
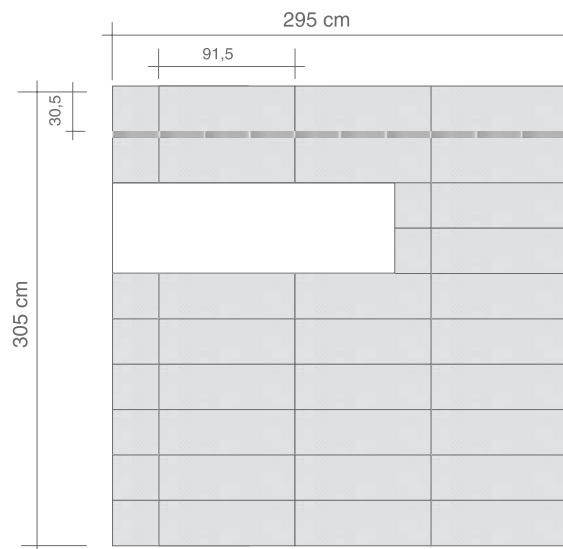

Wall B

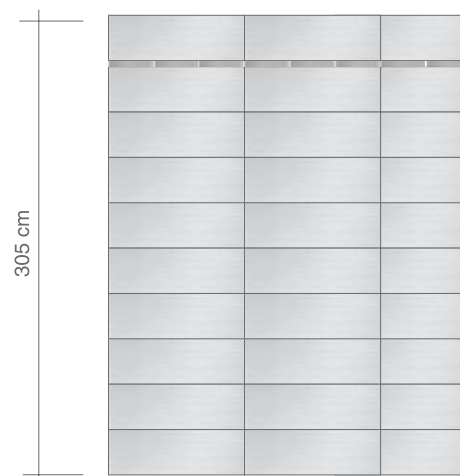

Wall A

Amore Gemma inserto 30,5x91,5 RT
 Variazione Bianco listello B 4x30,5 RT

Wall B

Variazione Bianco listello B 4x30,5 RT
 Cupido Gemma 30,5x91,5 RT

Wall C

Variazione modulo cubo 30,5x30,5x22

Wall D

Cupido Gemma mosaico 30,5x91,5 RT

Floor

Cupido Gemma 30,5x30,5 RT

Stucco-Grout Wall

TonosuTono 13 Verde

Stucco-Grout Floor

TonosuTono 13 Verde

Wall D

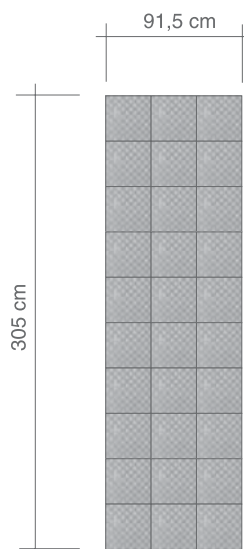

Wall C

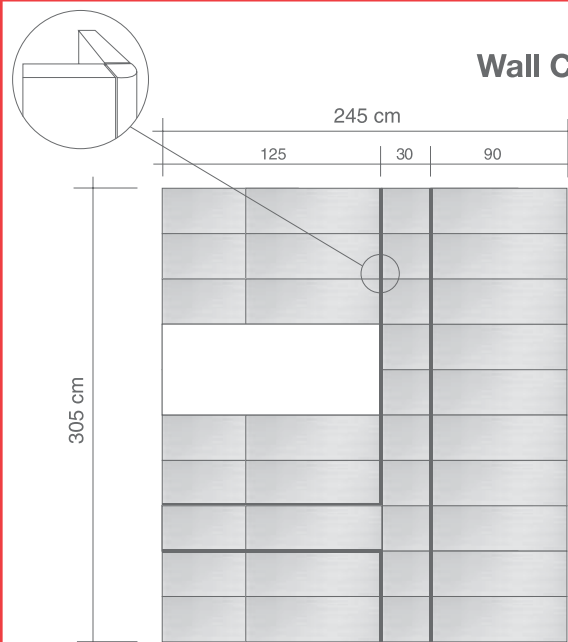

Wall A

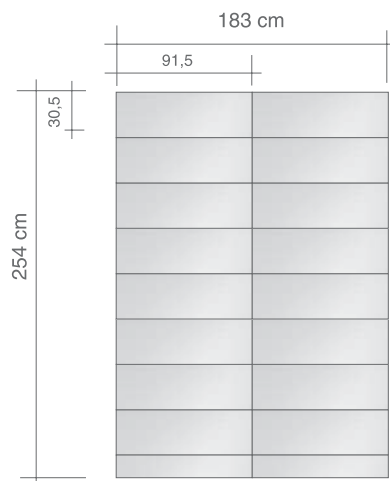

Wall B

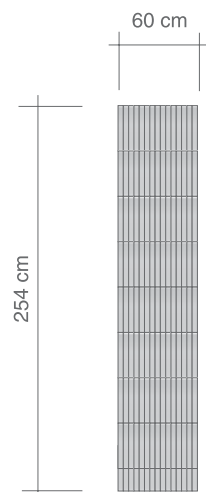

Wall C

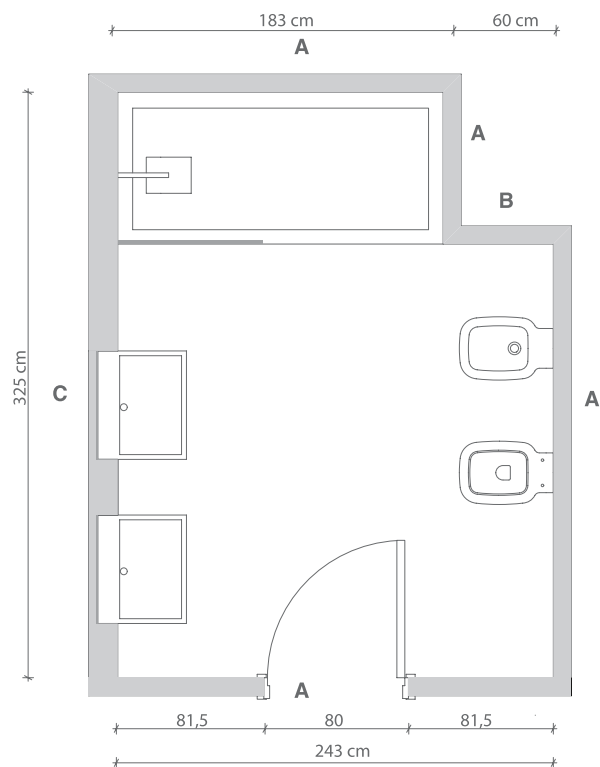
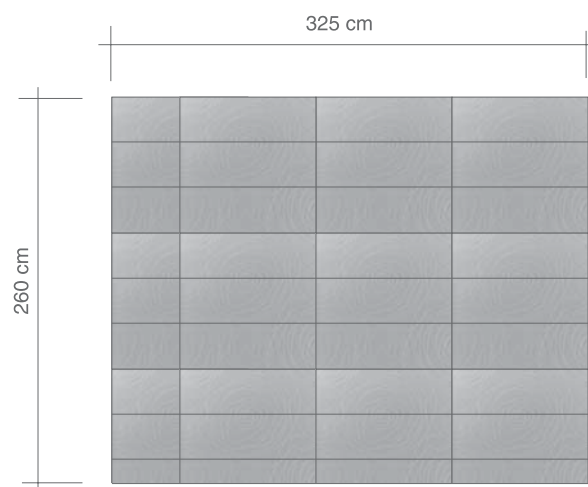

Wall A

Cupido Perla 30,5x91,5 RT

Wall B

Variazione Nero listello A 4x30,5 RT
Variazione Nero listello B 4x30,5 RT

Wall C

Opera Lavagna 30,5x91,5 RT

Floor

Cupido Perla 30,5x30,5 RT

Stucco-Grout Wall

TonosuTono 01 Bianco
TonosuTono 11 Antracite

Stucco-Grout Floor

TonosuTono 01 Bianco



Wall A

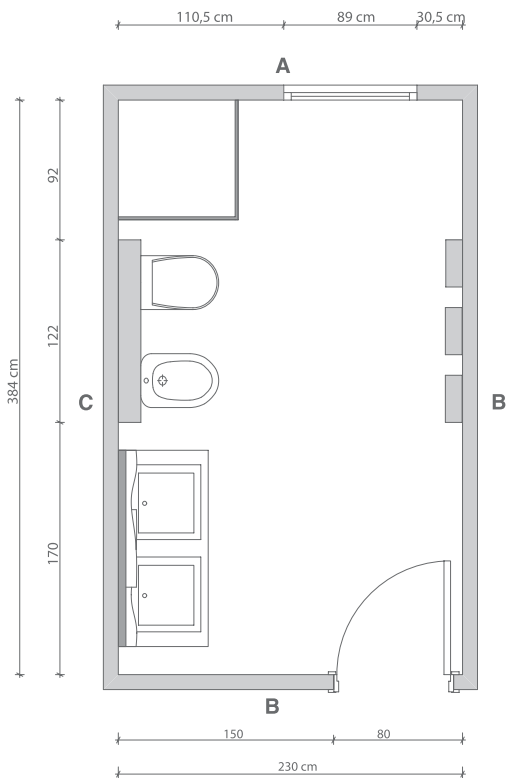
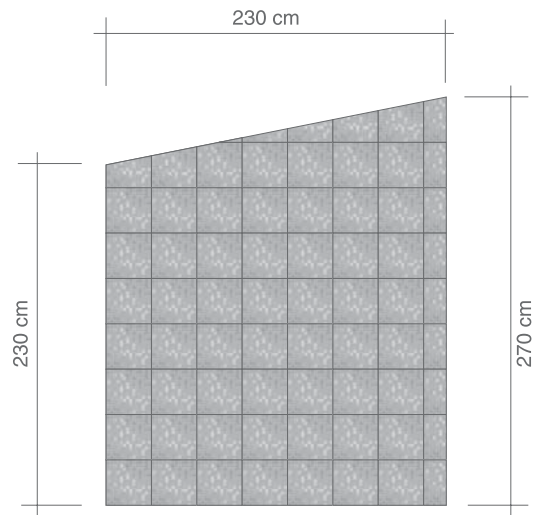

Wall B

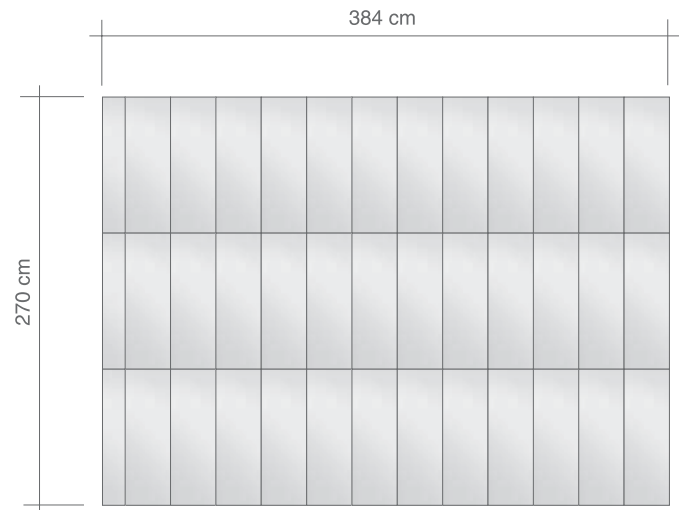

Wall C

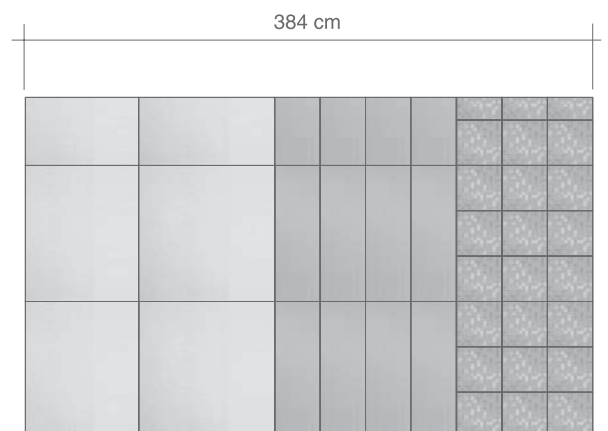

Wall A
Cupido Tortora Mosaico 30,5x30,5

Wall B
Cupido Cipria 30,5x91,5 RT

Wall C
Opera Rosa inserto Mix3 30,5x91,5 RT
Cupido Tortora 30,5x91,5 RT
Cupido Tortora Mosaico 30,5x30,5

Floor
Cupido Tortora 30,5x30,5 RT

Stucco-Grout Wall
TonosuTono 15 Magnolia

Stucco-Grout Floor
TonosuTono 10 Grigio

Wall A

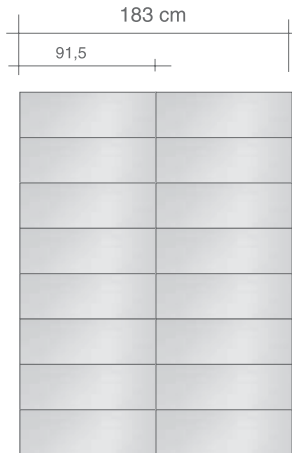

Wall B

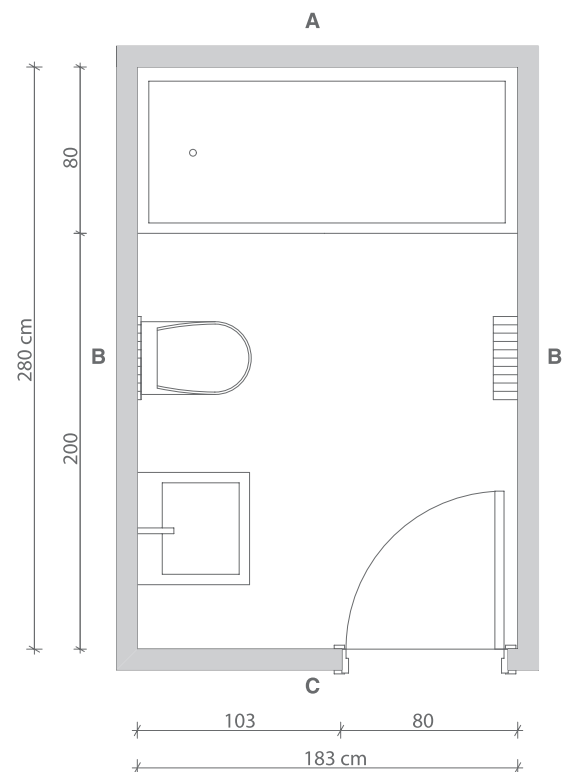
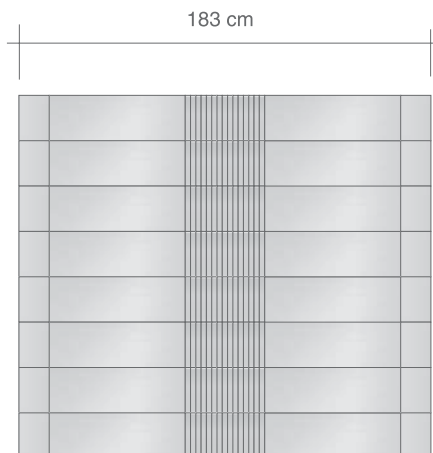

Wall C

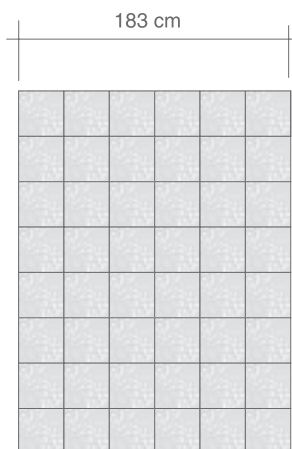

Wall A

Cupido Bianco mosaico 30,5x30,5

Wall B

Cupido Celeste 30,5x91,5 RT
 Variazione Bianco listello A 4x30,5 RT
 Variazione Bianco listello B 4x30,5 RT

Wall C

Cupido Celeste 30,5x91,5 RT

Floor

Cupido Celeste 30,5x30,5 RT

Stucco-Grout Wall

TonosuTono 01 Bianco
 TonosuTono 09 Azzurro

Stucco-Grout Floor

TonosuTono 09 Azzurro



Wall A

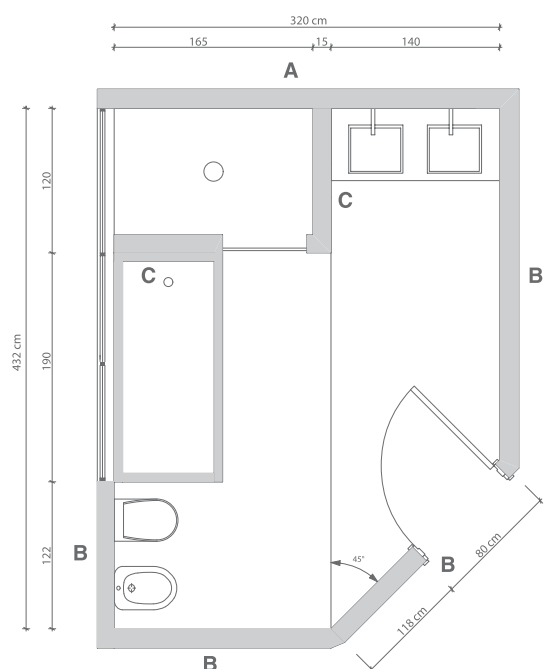
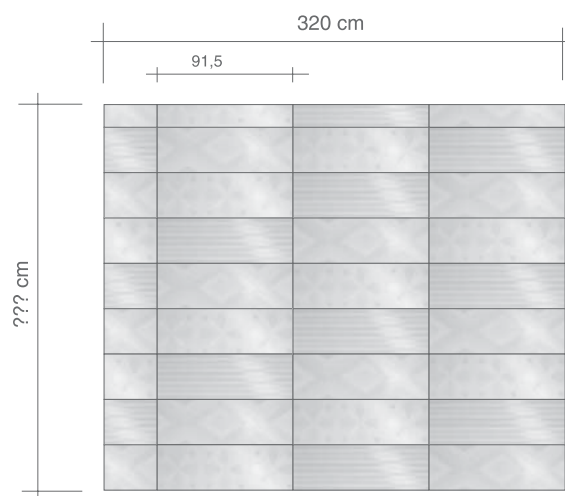

Wall B

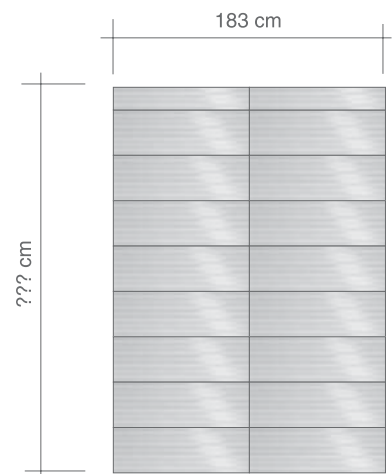

Wall A

Emozione Mandorla Rombi inserto Mix2 61x91,5 RT
 Emozione Mandorla Fiori inserto Mix2 61x91,5 RT
 Emozione Mandorla Righe inserto Mix2 61x91,5 RT

Wall B

Cupido Mandorla 30,5x91,5 RT

Wall C

Cupido Tortora 30,5x91,5 RT
 Spigolo Tortora 1,5x30,5 RT
 Cupido Mosaico Mandorla 30,5x30,5

Floor

Cupido Tortora 30,5x30,5 RT
 Cupido Mandorla 30,5x30,5 RT

Stucco-Grout Wall

TonosuTono 10 Grigio
 TonosuTono 02 Gesso

Stucco-Grout Floor

TonosuTono 02 gesso
 TonosuTono 10 Grigio

Wall C

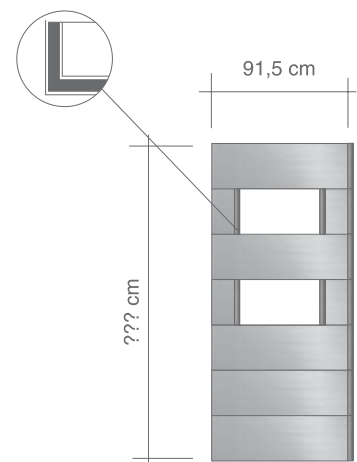

Wall A

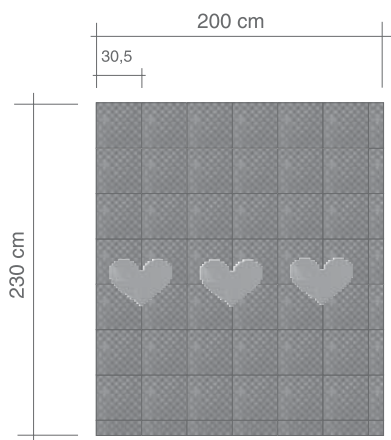

Wall B

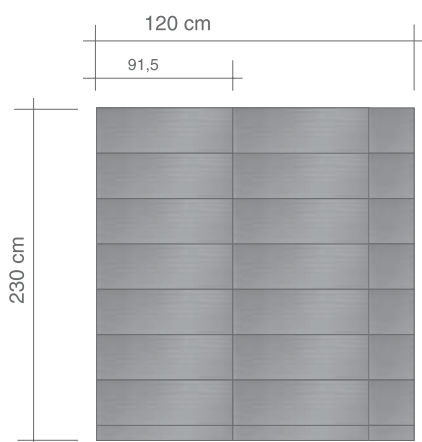

Wall C

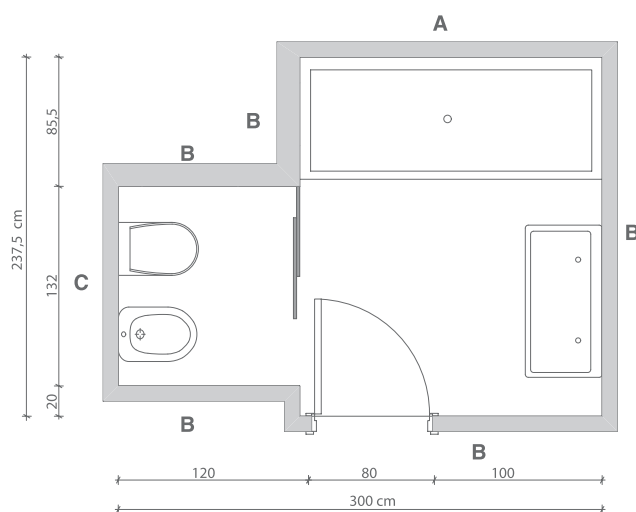
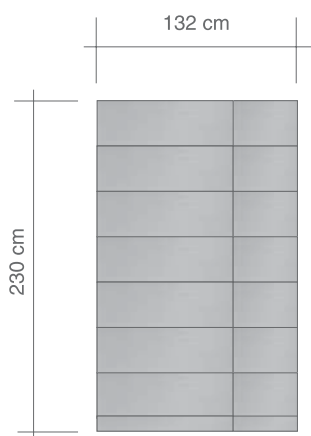

Wall A

Cuore Nero Mosaico 40x53,5
 Cuore Rosso Mosaico 40x53,5
 Cupido Modern Nero Mosaico 30,5x30,5

Wall B

Cupido Lavagna 30,5x91,5 RT

Wall C

Cupido Rosso 30,5x91,5 RT

Floor

Cupido Lavagna 30,5x30,5 RT

Stucco-Grout Wall

TonosuTono 11 Antracite
 TonosuTono 18 Rosso

Stucco-Grout Floor

TonosuTono 11 Antracite

RIVESTIMENTI WALL TILES - WANDFLIESEN
REVETEMENTS - REVESTIMIENTOS - ОБЛИЦОВОЧНАЯ ПЛИТКА

PASTA BIANCA WHITE BODY - WEISSKÖRPERIGER
PÂTE BLANCHE - PASTA BLANCA - БЕЛАЯ ГЛИНА

30,5x91,5
12"x36"

RT

SPESSORE 11,5 mm
THICKNESS - STÄRKE - ÉPAISSEUR - ESPESOR - ТОЛЩИНА



Cupido rosso 30,5x91,5 RT
TonosuTono **18 ROSSO**



Cupido rosso spigolo 1,5x30,5 RT



A.E.
spigolo
1,5x1,5



Cupido bianco 30,5x91,5 RT
TonosuTono **01 BIANCO**



Cupido bianco spigolo 1,5x30,5 RT



A.E.
spigolo
1,5x1,5

PAVIMENTI FLOOR TILES - BODENFLIESEN
SOLS - PAVIMENTOS - НАПОЛЬНАЯ ПЛИТКА

GRES PORCELLANATO PORCELAIN - FEINSTEINZEUG
GRES CERAME - GRES PORCELÁNICO - КЕРАМОГРАНИТ

30,5x30,5
12"x12"

RT

SPESSORE 8,6 mm
THICKNESS - STÄRKE - ÉPAISSEUR - ESPESOR - ТОЛЩИНА



For Love Metal argento 30,5x30,5 RT
TonosuTono **12 NERO**



Cupido perla 30,5x91,5 RT
TonosuTono **01 BIANCO**



Cupido perla spigolo 1,5x30,5 RT



A.E.
spigolo
1,5x1,5



Cupido celeste 30,5x91,5 RT
TonosuTono **09 AZZURRO**



Cupido celeste spigolo 1,5x30,5 RT



A.E.
spigolo
1,5x1,5

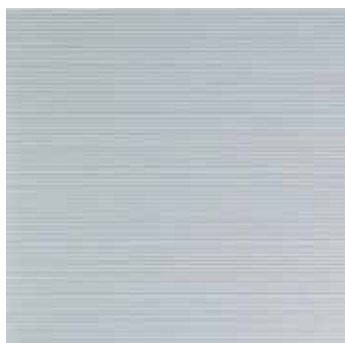

Cupido perla 30,5x30,5 RT
TonosuTono **01 BIANCO**

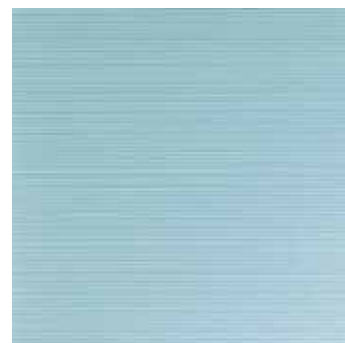

Cupido celeste 30,5x30,5 RT
TonosuTono **09 AZZURRO**

RIVESTIMENTI WALL TILES - WANDFLIESEN
REVETEMENTS - REVESTIMIENTOS - ОБЛИЦОВОЧНАЯ ПЛИТКА

PASTA BIANCA WHITE BODY - WEISSCHERBIGER
PÂTE BLANCHE - PASTA BLANCA - БЕЛАЯ ГЛИНА

30,5x91,5
12"x36"

RT

SPESSORE 11,5 mm
THICKNESS - STÄRKE - ÉPAISSEUR - ESPESOR - ТОЛЩИНА



Cupido tortora 30,5x91,5 RT
TonosuTono **10 GRIGIO**



Cupido tortora spigolo 1,5x30,5 RT



A.E.
spigolo
1,5x1,5



Cupido mandorla 30,5x91,5 RT
TonosuTono **02 GESSO**



Cupido mandorla spigolo 1,5x30,5 RT



A.E.
spigolo
1,5x1,5

PAVIMENTI FLOOR TILES - BODENFLIESEN
SOLS - PAVIMENTOS - НАПОЛЬНАЯ ПЛИТКА

GRES PORCELLANATO PORCELAIN - FEINSTEINZEUG
GRES CERAME - GRES PORCELÁNICO - КЕРАМОГРАНИТ

30,5x30,5
12"x12"

RT

SPESSORE 8,6 mm
THICKNESS - STÄRKE - ÉPAISSEUR - ESPESOR - ТОЛЩИНА

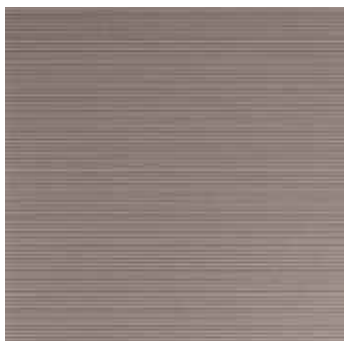

Cupido tortora 30,5x30,5 RT
TonosuTono **10 GRIGIO**



Cupido mandorla 30,5x30,5 RT
TonosuTono **02 GESSO**



Cupido gemma 30,5x91,5 RT
TonosuTono **13 VERDE**



Cupido gemma spigolo 1,5x30,5 RT



A.E.
spigolo
1,5x1,5



Cupido lavagna 30,5x91,5 RT
TonosuTono **11 ANTRACITE**



Cupido lavagna spigolo 1,5x30,5 RT



A.E.
spigolo
1,5x1,5



Cupido gemma 30,5x30,5 RT
TonosuTono **13 VERDE**



Cupido lavagna 30,5x30,5 RT
TonosuTono **11 ANTRACITE**

RIVESTIMENTI WALL TILES - WANDFLIESEN
REVETEMENTS - REVESTIMIENTOS - ОБЛИЦОВОЧНАЯ ПЛИТКА

PASTA BIANCA WHITE BODY - WEISSCHERBIGER
PÂTE BLANCHE - PASTA BLANCA - БЕЛАЯ ГЛИНА

30,5x91,5
12"x36"

RT

SPESSORE 11,5 mm
THICKNESS - STÄRKE - ÉPAISSEUR - ESPESOR - ТОЛЩИНА



Cupido cipria spigolo 1,5x30,5 RT



A.E.
spigolo
1,5x1,5

Cupido cipria 30,5x91,5 RT
TonosuTono 15 MAGNOLIA

PAVIMENTI FLOOR TILES - BODENFLIESEN
SOLS - PAVIMENTOS - НАПОЛЬНАЯ ПЛИТКА

GRES PORCELLANATO PORCELAIN - FEINSTEINZEUG
GRES CERAME - GRES PORCELÁNICO - КЕРАМОГРАНИТ

30,5x30,5
12"x12"

RT

SPESSORE 8,6 mm
THICKNESS - STÄRKE - ÉPAISSEUR - ESPESOR - ТОЛЩИНА



Cupido cipria 30,5x30,5 RT
TonosuTono 15 MAGNOLIA

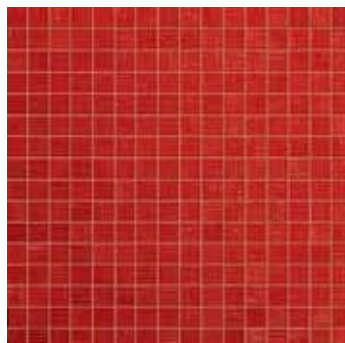

Cupido mosaico rosso 30,5x30,5*
TonosuTono **18 ROSSO**

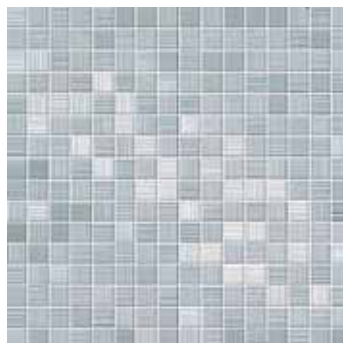

Cupido mosaico perla 30,5x30,5*
TonosuTono **01 BIANCO**

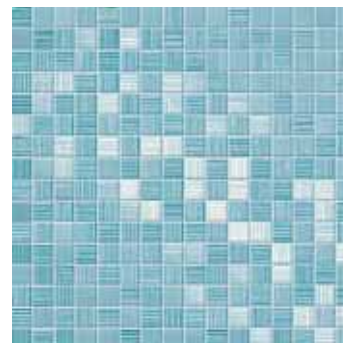

Cupido mosaico celeste 30,5x30,5*
TonosuTono **09 AZZURRO**



Cupido mosaico bianco 30,5x30,5*
TonosuTono **01 BIANCO**

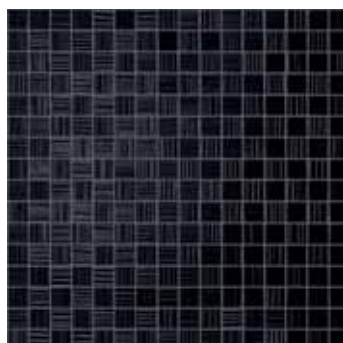

Cupido mosaico modern nero 30,5x30,5*
TonosuTono **12 NERO**



Cupido mosaico lavagna 30,5x30,5*
TonosuTono **11 ANTRACITE**



Cupido mosaico modern bianco 30,5x30,5*
TonosuTono **01 BIANCO**

* Formato tessera: 1,7x1,7 cm - Mosaic size: 1,7x1,7 cm - Mittelmosaik-Format: 1,7x1,7 cm - Petit format: 1,7x1,7 cm - Tamaño del mosaico: 1,7x1,7 cm. - Формат смальты: 1,7x1,7 см

** Formato tessera: 2,3x2,3 cm - Mosaic size: 2,3x2,3 cm - Mittelmosaik-Format: 2,3x2,3 cm - Petit format: 2,3x2,3 cm - Tamaño del mosaico: 2,3x2,3 cm. - Формат смальты: 2,3x2,3 см

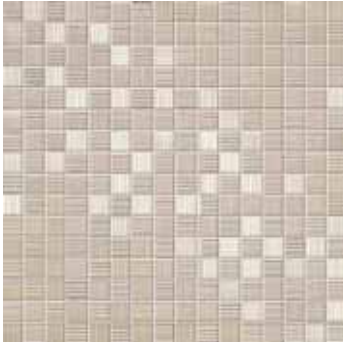

Cupido mosaico mandorla 30,5x30,5*
TonosuTono **02** GESSO

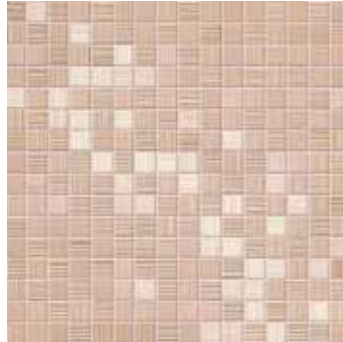

Cupido mosaico cipria 30,5x30,5*
TonosuTono **15** MAGNOLIA



Stream oro mosaico 30,5x30,5*
TonosuTono **02** GESSO



Cupido mosaico gemma 30,5x30,5*
TonosuTono **13** VERDE

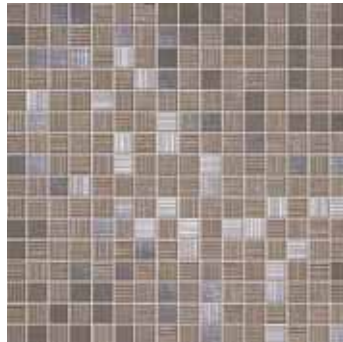

Cupido mosaico tortora 30,5x30,5*
TonosuTono **10** GRIGIO

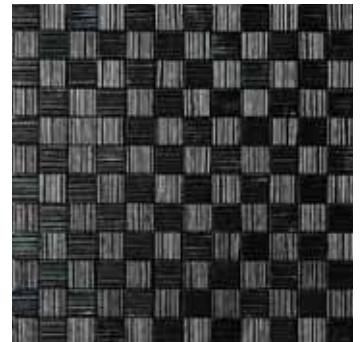

Stream mosaico 30,5x30,5**
TonosuTono **12** NERO

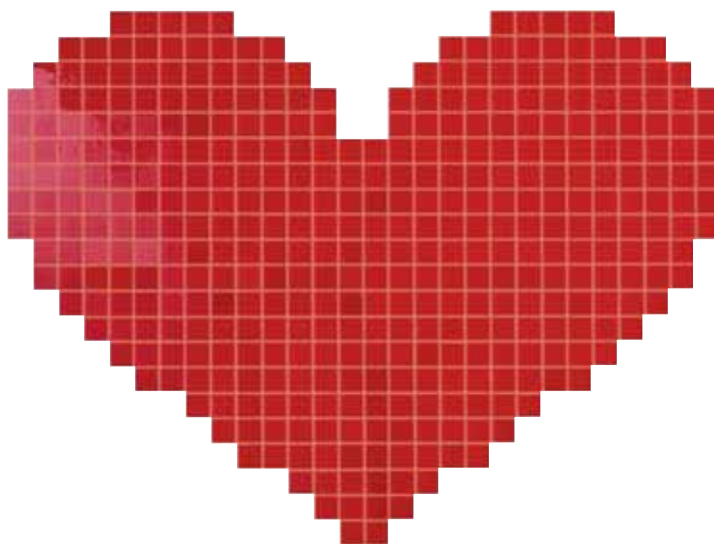

Cuore rosso mosaico 40x53,5*
TonosuTono **18 ROSSO**

□ Mosaico abbinabile
Matchable mosaic
Zusammenstellbare Mosaik
Mosaïques Pouvant s'associer
Mosaicos Combinables



Cupido mosaico rosso 30,5x30,5

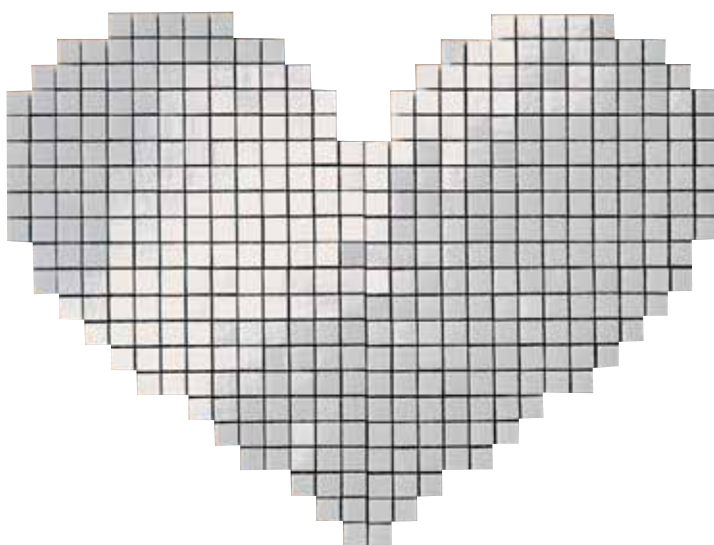

Cuore bianco mosaico 40x53,5*
TonosuTono **01 BIANCO**

□ Mosaico abbinabile
Matchable mosaic
Zusammenstellbare Mosaik
Mosaïques Pouvant s'associer
Mosaicos Combinables



Cupido mosaico bianco 30,5x30,5



Cuore nero mosaico 40x53,5* □
TonosuTono **12 NERO**

□ Mosaico abbinabile
Matchable mosaic
Zusammenstellbare Mosaik
Mosaïques Pouvant s'associer
Mosaicos Combinables

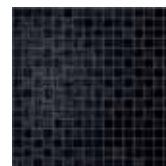

Cupido mosaico modern nero 30,5x30,5

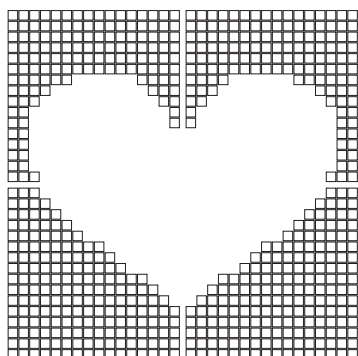

Per posare il cuore occorre predisporre il rivestimento, asportando una parte di tessere corrispondente alla sagoma del cuore stesso.

In order to lay the heart, the mosaic tiling must be prepared by removing a part of the tiles so that they fit around the shape of the heart. / Zunächst muss die Wandverkleidung vorbereitet werden, dann wird ein Teil der Mosaiksteinchen entfernt, um die Herzform zu erhalten. / Pour poser le cœur, il faut préparer le revêtement mural en enlevant une partie des tesselles correspondant au gabarit de celui-ci. / Para colocar el corazón hay que preparar el revestimiento, quitando una parte de teselas que corresponde a la forma del corazón. / Для укладки сердца следует подготовить облицовку, удалив часть элементов по шаблону сердца.



Cupido emozione colore rombi inserto mix 2 61x91,5 RT
TonosuTono 01 BIANCO

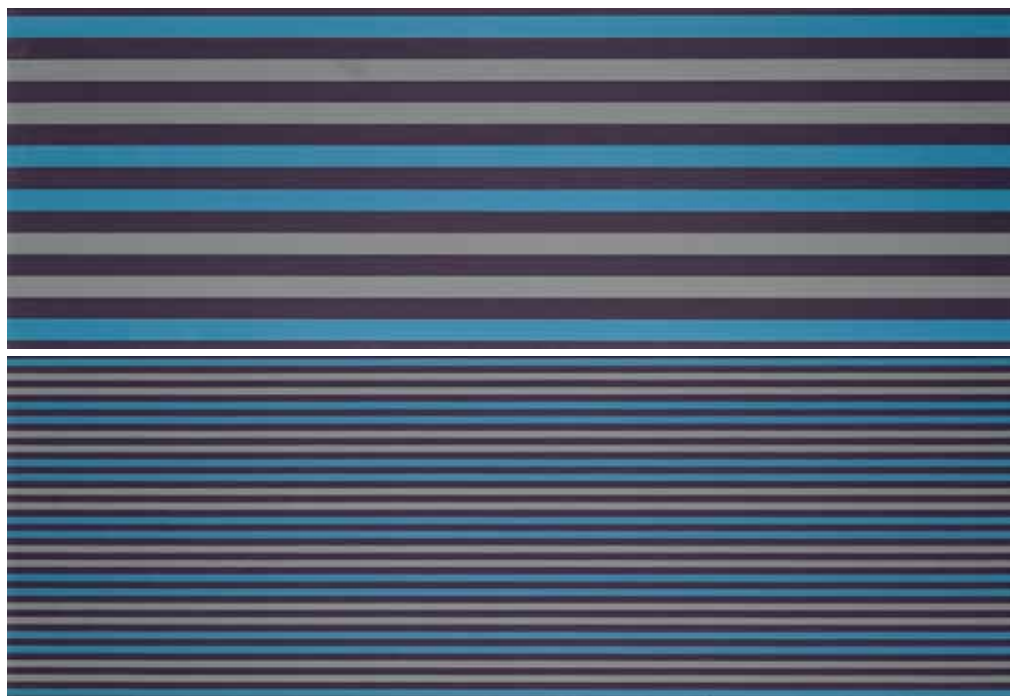

Cupido emozione colore righe inserto mix 2 61x91,5 RT
TonosuTono 01 BIANCO

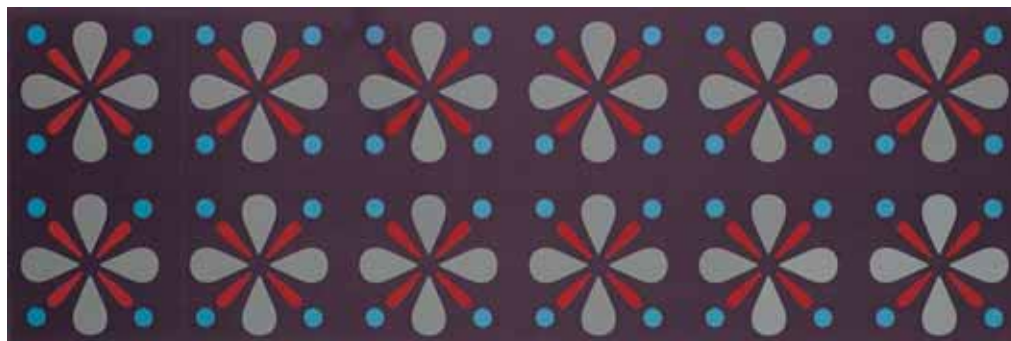

Cupido emozione colore fiori inserto mix 2 61x91,5 RT
TonosuTono 01 BIANCO



Cupido emozione colore listello 7x91,5 RT



Cupido emozione mandorla rombi inserto mix 2 61x91,5 RT
TonosuTono **02 GESSO**

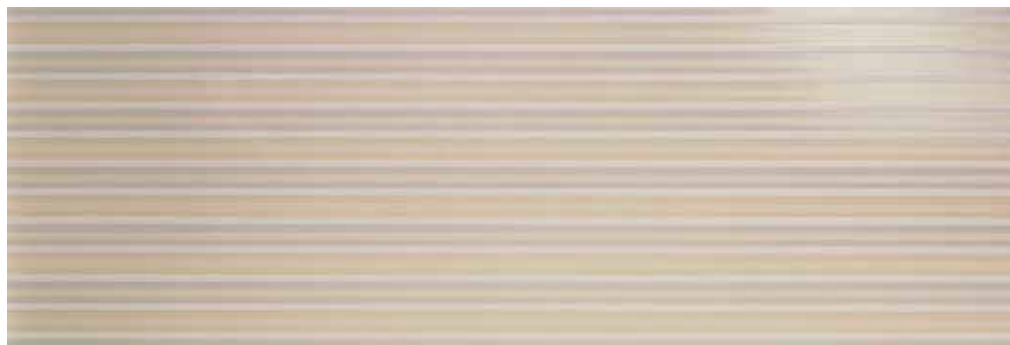

Cupido emozione mandorla righe inserto mix 2 61x91,5 RT
TonosuTono **02 GESSO**



Cupido emozione mandorla inserto mix 2 61x91,5 RT
TonosuTono **02** GESSO



Cupido emozione mandorla listello 7x91,5 RT



Cupido opera rosa inserto mix 3 91,5x91,5 RT
TonosuTono **15 MAGNOLIA**



Cupido opera rosa listello 4x91,5 RT

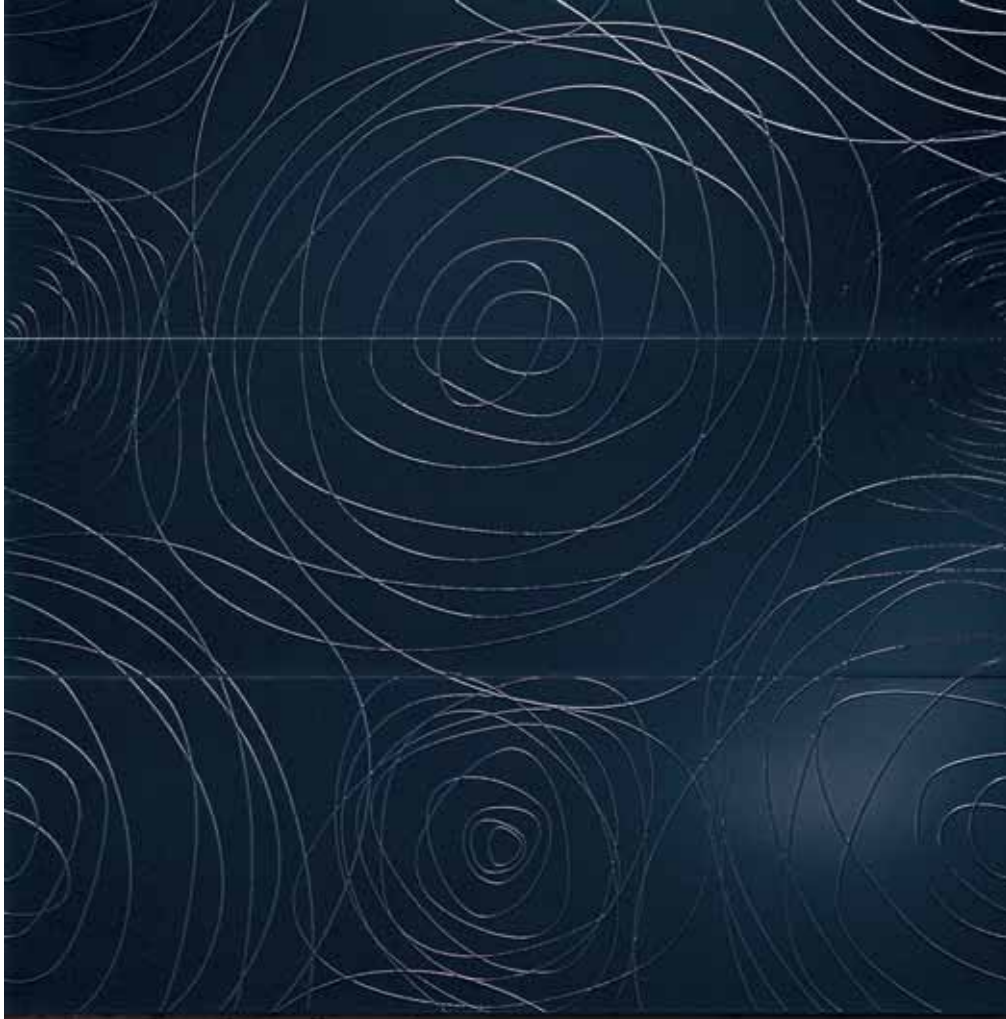

Cupido opera lavagna inserto mix 3 91,5x91,5 RT
TonosuTono 11 ANTRACITE



Cupido opera lavagna listello 4x91,5 RT



Cupido opera mandorla inserto mix 3 91,5x91,5 RT
TonosuTono **02 GESSO**



Cupido opera mandorla listello 4x91,5 RT



Stream oro inserto 30,5x91,5 RT



Stream argento inserto 30,5x91,5 RT



Stream oro listello 2,5x30,5 RT



Stream oro listello 2,5x91,5 RT



Stream argento listello 2,5x91,5 RT



Cupido gelosia bianco inserto
30,5x91,5 RT
TonosuTono **01 BIANCO**



cupido gelosia bianco listello 9,5x30,5 RT



Cupido gelosia celeste inserto
30,5x91,5 RT
TonosuTono **09 AZZURRO**



cupido gelosia celeste listello 9,5x30,5 RT



Cupido gelosia mandorla inserto
30,5x91,5 RT
TonosuTono **02 GESSO**



cupido gelosia mandorla listello 9,5x30,5 RT



Cupido gelosia lavagna inserto
30,5x91,5 RT
TonosuTono **11** ANTRACITE



cupido gelosia lavagna listello 9,5x30,5 RT



Cupido amore bianco rosso inserto 30,5 x 91,5 RT
TonosuTono **01** BIANCO



cupido amore bianco rosso listello 6,5 x 91,5 RT

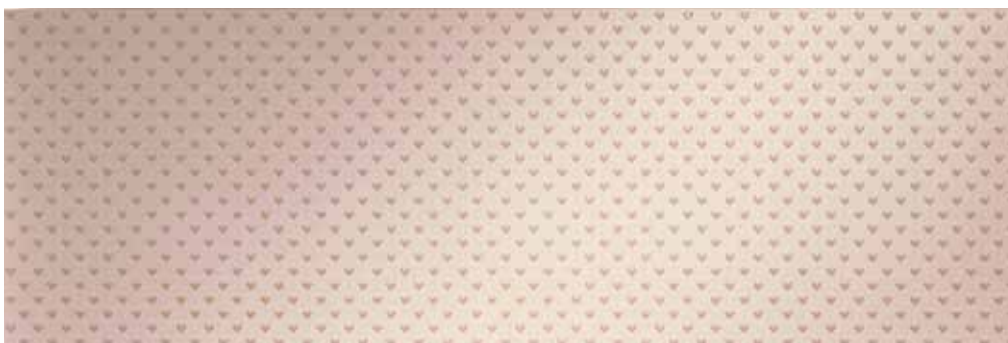

Cupido amore cipria magnolia inserto 30,5 x 91,5 RT
TonosuTono **15** MAGNOLIA

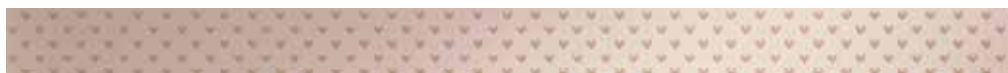

cupido gelosia cipria magnolia listello 6,5 x 91,5 RT



Cupido amore gemma inserto 30,5 x 91,5 RT
TonosuTono **13 VERDE**



cupido amore gemma listello 6,5 x 91,5 RT

TonosuTono

stuccature coordinate Fap.

Si insinua con agilità. Si intona con armonia. Si mette in mostra con discrezione. E con un preciso obiettivo: valorizzare al meglio le ceramiche di Fap, minimizzando l'impatto estetico delle fughe.

È TonosuTono di Fap, l'innovativa linea di stuccature di colore coordinato, in grado di esaltare la bellezza delle ceramiche, la soluzione ideale per tutti i tipi di posa, a giunto unito o con fuga. Un'articolata gamma di esclusive cromie da utilizzare anche unitamente alla nuova materia glitter, per fare brillare di luce ogni più piccolo dettaglio.

TonosuTono è un prodotto "made in Italy" di grande qualità, i cui requisiti tecnici rispettano le più severe normative internazionali in materia.

It artfully sneaks in. It tones in with harmony. It discreetly attracts attention. It has a clear objective: to enhance Fap ceramic tiles minimising the aesthetic impact of the joints. This is TonosuTono by Fap, the innovative line of colour coordinated grout that enhances the beauty of ceramic tiles; the ideal solution for all types of laying compositions, with joints or closed joints. A wide range of exclusive colours to be used also in combination with the new material called glitter, to add a brilliant touch of light even to the smallest detail. TonosuTono is a top quality "made in Italy" product with technical characteristics that comply with the strictest international standards in this sector. / Sie schleicht sich ganz geschickt in Ihr Bad ein. Sie stimmt sich harmonisch auf Ihre Fliesen ab. Sie stellt sich ganz zurückhaltend zur Schau. Und dabei hat sie ein genaues Ziel: Sie will der Keramik von Fap zur Geltung verhelfen, indem sie die Fugen weniger ins Auge fallen lässt. Das ist TonosuTono von Fap, eine Fugenmasse, die farblich auf die Fliesen abgestimmt ist und so die Schönheit der Fliesen betont. Die ideale Lösung für alle Verlegungsarten, fugenlos und mit Fugen. Ein reiches Sortiment an exklusiven Farbtönen ist erhältlich, die auch zusammen mit dem neuen Material glitter verwendet werden können, um jedes kleine Detail erstrahlen zu lassen. TonosuTono ist ein hochwertiges, italienisches Erzeugnis, dessen technische Eigenschaften die strengsten, einschlägigen internationalen Standards berücksichtigen. / Elle se glisse avec adresse. Elle s'assortit avec harmonie. Elle a une présence discrète. Et son objectif est bien précis: rehausser au maximum les carreaux Fap en limitant l'impact esthétique des joints. Il s'agit de TonosuTono de Fap, l'extraordinaire ligne de mortiers de couleur assortie, en mesure de faire ressortir la beauté des carreaux; la solution idéale pour tous les types de pose, à joints fermés ou à joints ouverts. Une large gamme de couleurs exclusives à utiliser aussi avec le nouveau matériau glitter, pour faire briller de mille feux tous les petits détails. TonosuTono est un produit de première qualité Made in Italy, dont les propriétés techniques respectent les plus strictes normes internationales du secteur. / Se insinúa con habilidad. Se combina con armonía. Se deja ver con discreción. Y con un objetivo preciso: valorizar de la mejor manera las cerámicas, minimizando el impacto estético de las juntas. Es TonosuTono de Fap, la innovadora línea de materiales de rejuntado de color combinado, capaz de resaltar la belleza de las cerámicas; la solución ideal para todo tipo de colocaciones, ya sea con junta o de junta unida. Una articulada gama de exclusivas tonalidades de color que también puede utilizarse con la nueva materia glitter, para hacer brillar de luz cada mínimo detalle. TonosuTono es un producto "made in Italy" de gran calidad, cuyos requisitos técnicos cumplen las más severas normativas internacionales en la materia. / Легкая, гармоничная, деликатная. Новая затирка выделяет качество и эстетические достоинства керамики Fap, сводя к минимуму оптический эффект швов. Новейшая линия затирок координированных цветов TonosuTono производства компании Fap подчеркивает красоту керамики и отлично подходит для любого типа укладки как встык, так и с межплиточным швом. В добавление к обширной гамме эксклюзивных цветов новый материал glitter наполняет светом и блеском каждую мельчайшую деталь покрытия. Итальянское высококачественное изделие TonosuTono "made in Italy" отличается техническими характеристиками в соответствии с самыми строгими международными стандартами.

01 BIANCO



02 GESSO



03 BEIGE



04 CREMA



05 ROSA



07 CIPRIA



08 BLU



09 AZZURRO



10 GRIGIO



11 ANTRACITE



12 NERO



13 VERDE



14 MARRONE



15 MAGNOLIA



16 TABACCO



17 CELESTE



una nuova tonalità completa la gamma >>

a new tone to complete the range / ein neuer Farbton vervollständigt das Sortiment / la gamme accueille une nouvelle couleur / una nueva tonalidad completa la gama / новый оттенок дополняет гамму цветов.

18 ROSSO



glitter, l'innovativa polvere di luce della linea TonosuTono di Fap, mescolata ad ogni colore ne esalta la bellezza rendendo davvero affascinante ed unico l'effetto cromatico.

glitter, the innovative glittery powder part of the TonosuTono line by Fap, which mixed to any colour enhances its beauty creating a unique and alluring chromatic effect. / **glitter**, der innovative Lichtstaub der Linie TonosuTono von Fap, kann mit jedem Farbton gemischt werden und erzeugt faszinierende und einzigartige Farbwirkungen. / **glitter**, l'incroyable poudre de lumière de la ligne TonosuTono de Fap, se mêle à toutes les couleurs pour exalter leur beauté et créer un effet chromatique vraiment charmant et unique. / **glitter**, el innovador polvo de luz de la línea TonosuTono de Fap, resalta la belleza de cada color, al ser mezclados, dando lugar a un efecto cromático verdaderamente fascinante y único. / Новый тончайший порошок **glitter** линии TonosuTono компании Fap можно перемешивать с любым цветом затирки, подчеркивая ее красоту и придавая ей изысканность и хроматическую уникальность.



Informazioni utili

Useful information. / Nützliche Informationen. / Informations utiles. / Información útil. / Полезная информация.

Rivestimenti in pasta bianca

White body wall tiles / Weißscherbiger Wandfliesen / Revêtements en pâte blanche / Revestimientos en pasta blanca

CARATTERISTICHE TECNICHE	TECHNICAL SPECIFICATIONS	TECHNISCHE EIGENSCHAFTEN	CARACTERISTIQUES TECHNIQUES	CARACTERÍSTICAS TÉCNICAS	ТЕХНИЧЕСКИЕ ХАРАКТЕРИСТИКИ	NORME STANDARDS NORMEN NORMES NORMAS НОРМЫ	VALORE PRESCRITTO VALUES REQUIRED NORMVORGABE VALEUR PRESCRITE VALOR PRESCRITO ЗАНЯТОЕ ЗНАЧЕНИЕ EN 14411 ISO 13006 - BIII (GL)	VALORE MEDIO FAP* AVERAGE FAP RATING DURCHSCHNITTSWERT FAP VALEUR MOYENNE FAP VALOR MEDIO FAP СРЕДНЕЕ ЗНАЧЕНИЕ FAP BIII (GL)
Lunghezza e larghezza Spessore Ortogonalità Rettilinearità degli spigoli Planarità Aspetto della superficie % senza difetti nel lotto di prova	Lenght and width Thickness Wedging Straightness of the edges Flatness Quality of the surface Faultless % within the sample lot	Seitenlänge Stärke Rechtwinkligkeit Kantengeradheit Ebenflächigkeit Oberflächenqualität % an fehlerfreien Fliesen im Prüfbett	Dimensions des côtés Epaisseur Orthogonalité Equerrage des angles Planéité Qualité de la surface % sans défauts dans le lot d'essai	Largo y ancho Espesor Ortogonalidad Rectilinearidad de las aristas Planicidad Aspecto de la superficie % sin defectos en el lote de prueba	Длина и ширина Толщина Ортогональность Прямолинейность углов Плоскость Вид поверхности % без брака в пробной партии	EN ISO 10545-2	± 0,5% ± 5% ± 0,6% ± 0,5% ± 0,5% ≥ 95%	± 0,3% ± 5% ± 0,3% ± 0,3% ± 0,3% ≥ 95%
Assorbimento d'acqua Valore medio %	Water absorption Average value %	Wasseraufnahme Durchschnittswert %	Absorption d'eau Valeur moyenne %	Absorción de agua Valor medio %	Водопоглощение Среднее значение %	EN ISO 10545-3	> 10%	Conforme - In accordance Erfüllt - Conforme Соответствует
Resistenza alla flessione Carico di rottura in N Carico di rottura in N/mm ²	Bending strength Breaking force in N Breaking force in N/mm ²	Biegefestigkeit Bruchlast in N Bruchlast in N/mm ²	Résistance à la flexion Charge de rupture en N Charge de rupture en N/mm ²	Resistencia a la flexión Carga de rotura en N Carga de rotura en N/mm ²	Прочность при изгибе Разрушающая нагрузка в N Разрушающая нагрузка в N/mm ²	EN ISO 10545-4	≥ 600 ≥ 15	Conforme In accordance Erfüllt - Conforme Соответствует
Resistenza agli sbalzi termici	Thermal shock resistance	Temperaturwechselbeständigkeit	Résistance aux écarts de température	Resistencia a los choques térmicos	Стойкость к перепадам температуры	EN ISO 10545-9	Metodo di prova disponibile Test method available Verfügbare Prüfmethode Méthode d'essai disponible Método de prueba disponible Доступный метод испытания	Conforme In accordance Erfüllt Conforme Соответствует
Resistenza al cavillo	Crazing resistance	Haarriß-Beständigkeit	Résistance aux craquelures	Resistencia al cuarteado	Сопrotivляемость образованию кракелюров	EN ISO 10545-11	Richiesta - Requested Gefordert - Exigée Solicitud Требуемое значение	Conforme - In accordance Erfüllt - Conforme Соответствует
Resistenza ai prodotti chimici	Chemical resistance	Chemikalienfestigkeit	Résistance aux produits chimiques	Resistencia a los productos químicos	Сопrotivляемость воздействию химических веществ	EN ISO 10545-13	GB MIN	Conforme - In accordance Erfüllt - Conforme Соответствует
Resistenza alle macchie	Stain resistance	Bständigkeit gegen Fleckenbildung	Résistance aux taches	Resistencia a las manchas	Стойкость к загрязнению	EN ISO 10545-14	≥ Classe - Class - Klasse Classe - Класс 3	Classe - Class - Klasse Classe - Класс 5

Pavimenti in gres porcellanato

Porcelain floor tiles / Bodenfliesen Feinsteinzeug / Sols gres cerame / Pavimentos en gres porcelánico / Напольная плитка из керамогранита

CARATTERISTICHE TECNICHE	TECHNICAL SPECIFICATIONS	TECHNISCHE EIGENSCHAFTEN	CARACTERISTIQUES TECHNIQUES	CARACTERÍSTICAS TÉCNICAS	ТЕХНИЧЕСКИЕ ХАРАКТЕРИСТИКИ	NORME STANDARDS NORMEN NORMES NORMAS НОРМЫ	VALORE PRESCRITTO VALUES REQUIRED NORMVORGABE VALEUR PRESCRITE VALOR PRESCRITO ЗАНЯТОЕ ЗНАЧЕНИЕ EN 14411 ISO 13006 BIIa (UGL e GL)	VALORE MEDIO FAP* AVERAGE FAP RATING DURCHSCHNITTSWERT FAP VALEUR MOYENNE FAP VALOR MEDIO FAP СРЕДНЕЕ ЗНАЧЕНИЕ FAP BIIa (GL)
Lunghezza e larghezza Spessore Ortogonalità Rettilinearità degli spigoli Planarità Aspetto della superficie % senza difetti nel lotto di prova	Lenght and width Thickness Wedging Straightness of the edges Flatness Quality of the surface Faultless % within the sample lot	Seitenlänge Stärke Rechtwinkligkeit Kantengeradheit Ebenflächigkeit Oberflächenqualität % an fehlerfreien Fliesen im Prüfbett	Dimensions des côtés Epaisseur Orthogonalité Equerrage des angles Planéité Qualité de la surface % sans défauts dans le lot d'essai	Largo y ancho Espesor Ortogonalidad Rectilinearidad de las aristas Planicidad Aspecto de la superficie % sin defectos en el lote de prueba	Длина и ширина Толщина Ортогональность Прямолинейность углов Плоскость Вид поверхности % без брака в пробной партии	EN ISO 10545-2	± 0,5% ± 5% ± 0,6% ± 0,5% ± 0,5% ≥ 95%	± 0,3% ± 5% ± 0,3% ± 0,3% ± 0,3% ≥ 95%
Assorbimento d'acqua Valore medio	Water absorption Average value	Wasseraufnahme Durchschnittswert	Absorption d'eau Valeur moyenne	Absorción de agua Valor medio	Водопоглощение Среднее значение %	EN ISO 10545-3	≤ 0,5%	Conforme - In accordance Erfüllt - Conforme Соответствует
Resistenza alla flessione Carico di rottura in N Carico di rottura in N/mm ²	Bending strength Breaking force in N Breaking force in N/mm ²	Biegefestigkeit Bruchlast in N Bruchlast in N/mm ²	Résistance à la flexion Charge de rupture en N Charge de rupture en N/mm ²	Resistencia a la flexión Carga de rotura en N Carga de rotura en N/mm ²	Прочность при изгибе Разрушающая нагрузка в N Разрушающая нагрузка в N/mm ²	EN ISO 10545-4	≥ 1300 ≥ 35	Conforme - In accordance Erfüllt - Conforme Соответствует
Resistenza agli sbalzi termici	Thermal shock resistance	Temperaturwechselbeständigkeit	Résistance aux écarts de température	Resistencia a los choques térmicos	Стойкость к перепадам температуры	EN ISO 10545-9	Metodo di prova disponibile Test method available Verfügbare Prüfmethode Méthode d'essai disponible Método de prueba disponible Доступный метод испытания	Conforme - In accordance Erfüllt - Conforme Соответствует
Resistenza all'abrasione (PEI)	Resistance to abrasion (PEI)	Abriebsfestigkeit (PEI)	Résistance à l'abrasion (PEI)	Resistencia a la abrasión (PEI)	Сопrotivление истиранию (PEI)	EN ISO 10545-7 PEI	Riportare la classe Indicate the class Klassenangabe gefordert Indiquer la classe Indicar la clase Передать класс.	Conforme - In accordance Erfüllt - Conforme Соответствует
Resistenza al gelo	Frost resistance	Frostbeständigkeit	Résistance au gel	Resistencia al hielo	Морозостойчивость	EN ISO 10545-12	Richiesta - Requested Gefordert - Exigée Solicitud Требуемое значение	Lavagna, Metal argento: PEI II Celeste, Tortora: PEI IV Cipria, Gemma, Mandorla, Perla: PEI V
Resistenza ai prodotti chimici	Chemical resistance	Chemikalienfestigkeit	Résistance aux produits chimiques	Resistencia a los productos químicos	Сопrotivляемость воздействию химических веществ	EN ISO 10545-13	GB - MIN	Conforme (1) - In accordance Erfüllt - Conforme Соответствует
Resistenza alle macchie	Stain resistance	Bständigkeit gegen Fleckenbildung	Résistance aux taches	Resistencia a las manchas	Стойкость к загрязнению	EN ISO 10545-14	≥ Classe - Class Klasse - Clase 3 - Класс 3	Classe - Class Klasse - Clase 3 - Класс 5

Misure, pesi ed imballi

Size, weight and packaging - Masse, Gewicht und Verpackung - Format, poids conditionnement - Medidas, pesos y embalajes - Размеры, вес и упаковка

Rivestimenti 30,5x91,5 Rettificati e Pavimenti coordinati.

Wall tiles in size 30,5x91,5 (12"x36") and matching floor tiles. / Wandfliesen im Format 30,5x91,5 und dazu passende Bodenfliesen. / Revêtements muraux en 30,5x91,5 et sols coordonnés. / Revestimientos 30,5x91,5 y pavimentos coordinados. Ректифицированная настенная плитка 30,5x91,5 и напольная плитка в комплекте.

	FORMATO IN CM E POLLICI SIZE IN CM AND INCHES FORMAT IN CM UND ZOLL FORMAT EN CM ET POUÇES FORMATO EN CM Y PULGADAS ФОРМАТ В CM И ДЮЙМАХ	SPESSORE IN MM THICKNESS MM STÄRKE MM ÉPAISSEUR EN MM ESPESOR EN MM ТОЛЩИНА В MM	PZ/SCATOLA PIECES/BOX STÜCK/KARTON PIECES/BÔTE PIEZAS/CAJA ШТ. В КОРОБКЕ	MQ/SCATOLA MQ/BOX MQ/KARTON MQ/BÔTE MQ/CAJA КВ.М В КОРОБКЕ	ML/SCATOLA ML/BOX ML/KARTON ML/BÔTE ML/CAJA ПОСОНЬИ МЕТРОВ В КОРОБКЕ	KG/SCATOLA KG/BOX KG/KARTON KG/BÔTE KG/CAJA КТ В КОРОБКЕ	SCATOLA/PALLET BOX/PALLET KARTON/PALLET BÔTE/PALLET CAJA/PALET КОРОБОК В ПОДДОНЕ
Rivestimento	30,5x91,5 RT 12"x36"	11,5	4	1,116	-	24,40	40
Pavimento coordinato	30,5x30,5 RT 12"x12"	8,6	12	1,12	-	21,25	48
Mosaico	30,5x30,5 12"x12"	-	6	0,55	-	10,44	42
Cuore mosaico	40x53,5 16"x21"	-	1	-	-	7,00	-
Spigolo	1,5x30,5 RT 0,6"x12"	-	10	-	-	3,00	-
Angolo esterno spigolo	1,5x1,5 0,6"x0,5"	-	4	-	-	0,05	-
Amore inserto	30,5x91,5 RT 12"x36"	-	2	-	-	12,20	-
Amore listello	6,5x91,5 RT 2,5"x36"	-	5	-	-	5,70	-
Emozione inserto mix 2	61x91,5 RT 24"x36"	-	1 mix	-	-	12,20	-
Emozione listello	7x91,5 RT 2,7"x36"	-	5	-	-	6,10	-
Gelosia inserto	30,5x91,5 RT 12"x36"	-	2	-	-	12,20	-
Gelosia listello	9,5x30,5 RT 3,5"x12"	-	5	-	-	2,50	-
Passione inserto mix 3	91,5x91,5 RT 36"x36"	-	1 mix	-	-	18,30	-
Passione listello	4x91,5 RT 1,5"x36"	-	5	-	-	4,50	-
Stream inserto	30,5x91,5 RT 12"x36"	-	2	-	-	12,20	-
Stream listello	2,5x91,5 RT 1"x36"	-	5	-	-	2,75	-
Stream listello	2,5x91,5 RT 1"x36"	-	5	-	-	1,35	-

- Valore medio dei test condotti negli ultimi 24 mesi.
Average rating of tests conducted during the last 24 months.
Durchschnittswert der in den letzten 24 Monaten durchgeführten Tests.
Valeur moyenne des essais menés au cours des 24 derniers mois.
Valor medio de las pruebas llevadas a cabo en los últimos 24 meses.
Среднее значение испытаний, проведенных в течение последних 24 месяцев.

(1) L' articolo Metal Argento è resistente ai prodotti chimici di uso domestico, ma è attaccabile dall'acido cloridrico in alte concentrazioni. The Metal Argento product range is resistant to normal household chemicals but may be affected by highly-concentrated hydrochloric acid. Der Artikel Metal Argento ist beständig gegen im Haushalt eingesetzten Chemikalien, aber nicht gegen Chloridsäure in hohen Konzentrationen. L'article Metal Argento est résistant aux produits chimiques ménagers, mais pas à l'acide chlorhydrique à forte concentration. El artículo Metal Argento resiste a los productos químicos de uso doméstico, pero es atacable por el ácido clorhídrico en altas concentraciones. Продукт Metal Argento устойчив к химическим продуктам домашнего использования, но разъедается хлористоводородной кислотой высокой концентрации.

Pesi e imballi.

Weights and packaging. / Gewicht und Verpackungen. / Poids et emballages. / Peso y embalaje. / Вес и упаковка.

	FORMATO IN CM E POLLICI SIZE IN CM AND INCHES FORMAT IN CM UND ZOLL FORMAT EN CM ET POUÇES FORMATO EN CM Y PULGADAS ФОРМАТ В СМ И ДЮЙМАХ	SPESSORE IN MM THICKNESS MM STÄRKE MM ÉPAISSEUR EN MM ESPESOR EN MM ТОЛЩИНА В ММ	PZ/SCATOLA PIECES/BOX STÜCK/KARTON PIECES/BÔTE PIEZAS/CAJA ШТ. В КОРОБКЕ	MQ/SCATOLA MQ/BOX MO/KARTON MQ/BÔTE MQ/CAJA КВ.М В КОРОБКЕ	ML/SCATOLA ML/BOX ML/KARTON ML/BÔTE ML/CAJA ПОСОНЬИХ МЕТРОВ В КОРОБКЕ	KG/SCATOLA KG/BOX KG/KARTON KG/BÔTE KG/CAJA КГ В КОРОБКЕ	SCATOLA/PALLET BOX/PALLET KARTON/PALLET BÔTE/PALLET CAJA/PALLET КОРОБОК В ПОДДОНЕ
Tonosutono	-	-	-	-	-	5,00	96

Tabella consumi.

Usage table. / Tableau de consommation. / Verbrauchstabelle. / Tabla de consumos. / Таблица потребления

FORMATO PIASTRELLA IN CMXCM TILE SIZE IN CMXCM / FORMAT CARREAU EN CMXCM / FLIESENFORMAT IN CMXCM FORMATO AZULEJO EN CMXCM / РАЗМЕР ПЛИТКИ СМ X СМ	LARGHEZZA FUGA (MM) WIDTH OF GAP (MM) / LARGEUR JOINT (MM) / FUGENBREITE (MM) ANCHURA JUNTA (MM) / ШИРИНА ШВА (MM)	KG/MQ KG/M2 / KG/M2 KG/M2 / KG/M2 / КГ/КВ.М
Mosaico 2x2 / 2x2 mosaic / Mosaïque 2x2 / Mosaico 2x2 / Мозаика 2x2	0-2	1,20
20x20	0-2	0,30
15x56	0-2	0,25
25x45	0-2	0,22
30,5x30,5	0-2	0,24
30,5x56	0-2	0,20
30,5x91,5	0-2	0,17
45x45	0-2 0-3	0,18
60x60	0-2 0-3	0,15

Abbinamento piastrelle/stucco.

Tile / grout combinations. / Zusammenstellung Fliesen/Fugenmasse. / Carreaux / mortier assorti. / Combinación azulejos / material de relleno. / Сочетание плитка / штукатурка.

	STUCCO ABBINATO. COMBINED GROUT. / DAZUPASSENDE FUGENMASSE. MORTIER ASSORTI. / MATERIAL DE REJUNTADO. / СОЧЕТАЕМОЙ ШТУКАТУРКИ.
Cupido Bianco 30,5x91,5 RT	TonosuTono 01 BIANCO
Cupido Celeste 30,5x91,5 RT	TonosuTono 09 AZZURRO
Cupido Cipria 30,5x91,5 RT	TonosuTono 15 MAGNOLIA
Cupido Gemma 30,5x91,5 RT	TonosuTono 13 VERDE
Cupido Lavagna 30,5x91,5 RT	TonosuTono 11 ANTRACITE
Cupido Mandorla 30,5x91,5 RT	TonosuTono 02 GESSO
Cupido Perla 30,5x91,5 RT	TonosuTono 01 BIANCO
Cupido Rosso 30,5x91,5 RT	TonosuTono 18 ROSSO
Cupido Tortora 30,5x91,5 RT	TonosuTono 10 GRIGIO
For Love Metal Argento Pavimento 30,5x30,5 RT	TonosuTono 12 NERO
Cupido Bianco Mosaico 30,5x30,5	TonosuTono 01 BIANCO
Cupido Celeste Mosaico 30,5x30,5	TonosuTono 09 AZZURRO
Cupido Cipria Mosaico 30,5x30,5	TonosuTono 15 MAGNOLIA
Cupido Gemma Mosaico 30,5x30,5	TonosuTono 13 VERDE
Cupido Lavagna Mosaico 30,5x30,5	TonosuTono 11 ANTRACITE
Cupido Mandorla Mosaico 30,5x30,5	TonosuTono 02 GESSO
Cupido Perla Mosaico 30,5x30,5	TonosuTono 01 BIANCO
Cupido Rosso Mosaico 30,5x30,5	TonosuTono 18 ROSSO
Cupido Tortora Mosaico 30,5x30,5	TonosuTono 10 GRIGIO
Modern Bianco Mosaico 30,5x30,5	TonosuTono 01 BIANCO
Modern Nero Mosaico 30,5x30,5	TonosuTono 12 NERO
Stream Mosaico 30,5x30,5	TonosuTono 12 NERO
Oro Mosaico 30,5x30,5	TonosuTono 02 GESSO
Cuore Bianco Mosaico 40x53,5	TonosuTono 01 BIANCO
Cuore Nero Mosaico 40x53,5	TonosuTono 12 NERO
Cuore Rosso Mosaico 40x53,5	TonosuTono 12 NERO
Amore Bianco Rosso Inserto 30,5x91,5 RT	TonosuTono 01 BIANCO
Amore Cipria Inserto 30,5x91,5 RT	TonosuTono 15 MAGNOLIA
Amore Gemma Inserto 30,5x91,5 RT	TonosuTono 13 VERDE
Amore Bianco Rosso Listello 6,5x91,5 RT	TonosuTono 01 BIANCO
Amore Cipria Listello 6,5x91,5 RT	TonosuTono 15 MAGNOLIA
Amore Gemma Listello 6,5x91,5 RT	TonosuTono 13 VERDE
Emozione Rombi Colore Inserto Mix 2 61x91,5 RT	TonosuTono 01 BIANCO
Emozione Rombi Mandorla Inserto Mix 2 61x91,5 RT	TonosuTono 02 GESSO
Emozione Fiori Colore Inserto Mix 2 61x91,5 RT	TonosuTono 01 BIANCO
Emozione Fiori Mandorla Inserto Mix 2 61x91,5 RT	TonosuTono 02 GESSO
Emozione Righe Colore Inserto Mix 2 61x91,5 RT	TonosuTono 01 BIANCO
Emozione Righe Mandorla Inserto Mix 2 61x91,5 RT	TonosuTono 02 GESSO
Emozione Colore Listello 7x91,5 RT	TonosuTono 01 BIANCO
Emozione Mandorla Listello 7x91,5 RT	TonosuTono 02 GESSO
Gelosia Bianco Inserto 30,5x91,5 RT	TonosuTono 01 BIANCO
Gelosia Celeste Inserto 30,5x91,5 RT	TonosuTono 09 AZZURRO
Gelosia Lavagna Inserto 30,5x91,5 RT	TonosuTono 11 ANTRACITE
Gelosia Mandorla Inserto 30,5x91,5 RT	TonosuTono 02 GESSO
Gelosia Bianco Listello 9,5x30,5 RT	TonosuTono 01 BIANCO
Gelosia Celeste Listello 9,5x30,5 RT	TonosuTono 09 AZZURRO
Gelosia Lavagna Listello 9,5x30,5 RT	TonosuTono 11 ANTRACITE
Gelosia Mandorla Listello 9,5x30,5 RT	TonosuTono 02 GESSO
Passione Cipria Inserto Mix 3 91,5x91,5 RT	TonosuTono 15 MAGNOLIA
Passione Lavagna Inserto Mix 3 91,5x91,5 RT	TonosuTono 11 ANTRACITE
Passione Mandorla Inserto Mix 3 91,5x91,5 RT	TonosuTono 02 GESSO
Passione Cipria Listello 4x91,5 RT	TonosuTono 15 MAGNOLIA
Passione Lavagna Listello 4x91,5 RT	TonosuTono 11 ANTRACITE
Passione Mandorla Listello 4x91,5 RT	TonosuTono 02 GESSO
Stream Oro Inserto 30,5x91,5 RT	TonosuTono 02 GESSO
Stream Oro Listello 2,5x91,5 RT	TonosuTono 02 GESSO
Stream Oro Listello 2,5x91,5 RT	TonosuTono 02 GESSO