



oh!

# oh!

Catturare la perfezione. Immergersi nella tranquillità. Continuare a vivere la natura. E sentirsi piccoli davanti alla grandiosità, alla meraviglia, alla magica armonia che ci circonda. Forme, colori, equilibri che regalano attimi di infinito.

Seize perfection. Surround yourself in peace. Experience nature and feel how small you are amidst the grandeur, wonder and magical harmony of the world around us. Shapes, colors and perfect balances let you dip into the infinite. / Die Perfektion einfangen. Die Ruhe genießen. Die Natur erleben und sich klein und unbedeutend fühlen gegenüber der Großartigkeit, den Wundern, der magischen Harmonie, die uns umgibt. Formen, Farben, Harmonien, die uns unendliche Momente schenken. / Saisir la perfection. Plonger dans la quiétude. Continuer à vivre la nature. Se sentir tout petits face à la beauté, à la féerie et à la prodigieuse harmonie qui nous entoure. Des formes, des couleurs, des équilibres nous offrent des instants perpétuels. / Capturar la perfección. Sumergirse en la tranquilidad. Seguir viviendo la naturaleza. Y sentirse pequeños ante la grandiosidad, de la maravilla, de la mágica armonía que nos circunda. Formas, colores, equilibrios que regalan instantes de infinito. / Достичь совершенства. Погрузиться в спокойную атмосферу. Почувствовать наслаждение от природы. И ощутить себя на фоне величия, совершенства и волшебной гармонии окружающего интерьера. Формы, цвета и душевное равновесие дарят моменты бесконечного счастья.

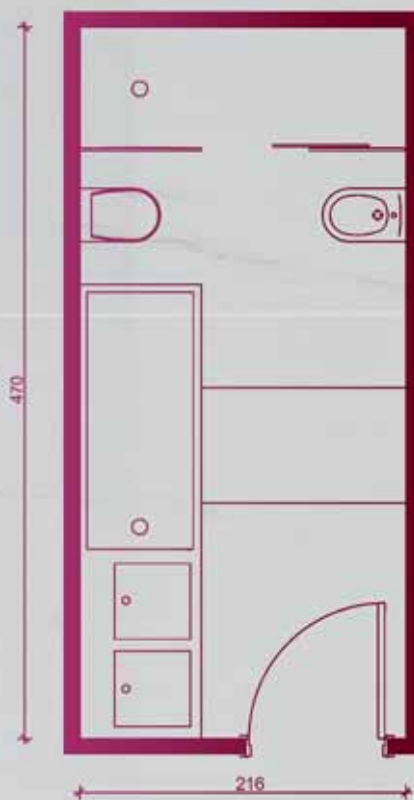

Il tuo bagno,  
la tua casa.

# ohlire!







Wall:

Oh! Oriente Beige 30,5x91,5 RT  
Oh! Oriente Terra 30,5x91,5 RT  
Opera Marrone Inserto Mix 3 91,5x91,5 RT  
Oh! Marrone Mosaico 30,5x30,5  
Gessato Oro Mosaico 30,5x30,5

Floor:

Evoluta Tweed 30,5x30,5 RT

TonosuTono:

TonosuTono 02 Gesso  
TonosuTono 16 Tabacco

Project on page 91





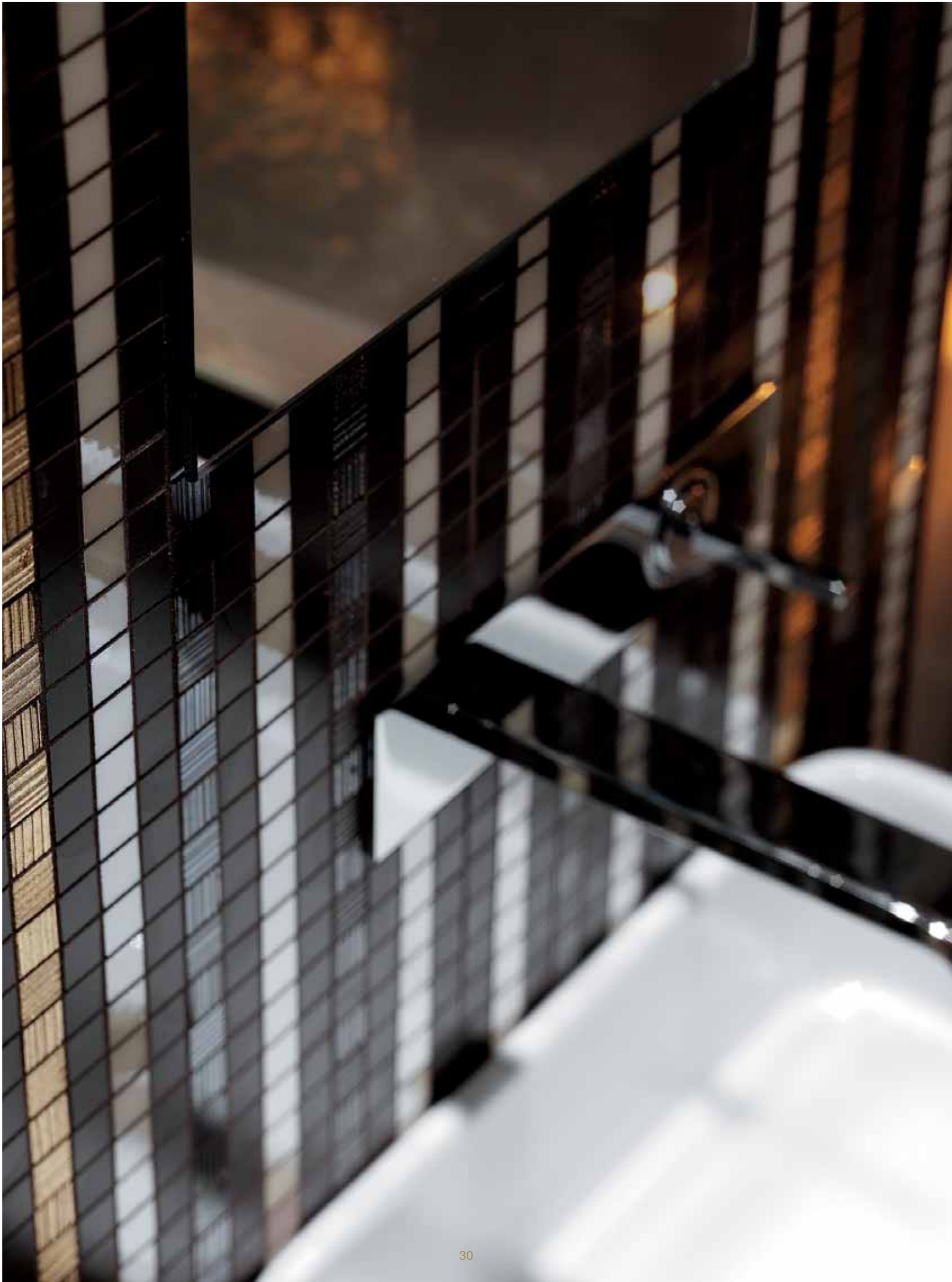





# oh!

Respiri che si abbracciano in un bouquet di leggerezza. È un dialogo discreto che si ripete in sottofondo, riempiendo l'ambiente con la sua intima presenza. Oh!

*Gentle sighs mingle in light bouquets. A quiet conversation is whispered in the background, filling the space with its cosy presence. Oh! / Atemzüge, die sich in einem Bouquet der Leichtigkeit umarmen. Ein diskreter Dialog, der sich im Hintergrund wiederholt und das Ambiente mit seiner intimen Gegenwart anfüllt. Oh! / Des souffles s'enlaçant en un bouquet de légèreté. Un dialogue discret qui se reproduit en fond sonore, remplissant l'espace de sa présence intime. Oh! / Suspiros que se abrazan en un bouquet de ligereza. Es un diálogo discreto que se repite como fondo, llenando el ambiente con su íntima presencia. Oh! / Легкое дыхание прекрасного в нежном букете цветов на фоне сдержанных красок. И помещение наполняется гармонией, бесконечно повторяющейся в каждой детали обстановки. Oh!*







# oh!

Oltrepassare l'orizzonte. Superare i confini. Varcare soglie proibite. E portare un pezzo di mondo fuori. Dentro. Un pensiero, una sensazione, un'emozione. Per dare al proprio bagno una identità davvero inconfondibile.

Beyond the horizon. Over the boundaries. Cross into unknown lands. Bring a piece of the outside world... inside. An idea, a feeling, an impression. Give your bathroom its very own distinctive identity. / Horizonte überwinden. Grenzen übertreten. Verbotene Schwellen überschreiten. Und ein Stück Welt nach außen tragen. Innen. Ein Gedanke, ein Gefühl, eine Emotion. Um Ihrem Bad einen wirklich unverwechselbaren Charakter zu verleihen. / Aller au-delà de l'horizon. Passer les frontières. Franchir les seuils interdits et emporter un peu du monde à l'extérieur. À l'intérieur. Une pensée, une sensation, une émotion. Pour donner à sa salle de bains une identité vraiment unique. / Cruzar el horizonte. Superar los confines. Atravesar límites prohibidos. Y llevar un trozo de mundo fuera. Dentro. Un pensamiento, una sensación, una emoción. Para dar al cuarto de baño una identidad realmente inconfundible. / Перейти за линию горизонта. Преодолеть границы. Переступить запретные пороги. И привнести часть внешнего мира внутрь, к себе. Мысли, ощущения, эмоции. Так ванная комната приобретает ни с чем несравнимый облик.



Il tuo bagno,  
la tua casa.

# ohrma!



Wall:  
Oh! Oriente Terra 30,5x91,5 RT  
Oh! Oriente Grigio 30,5x91,5 RT  
Orma Grigio Inserto 30,5x91,5 RT  
Orma Marrone Inserto 30,5x91,5 RT

Floor:  
Evoluta Tweed 30,5x30,5 RT  
Renova Grigio Perla 30,5x30,5 RT

TonosuTono:  
TonosuTono 16 Tabacco  
TonosuTono 01 Bianco

Project on page 92



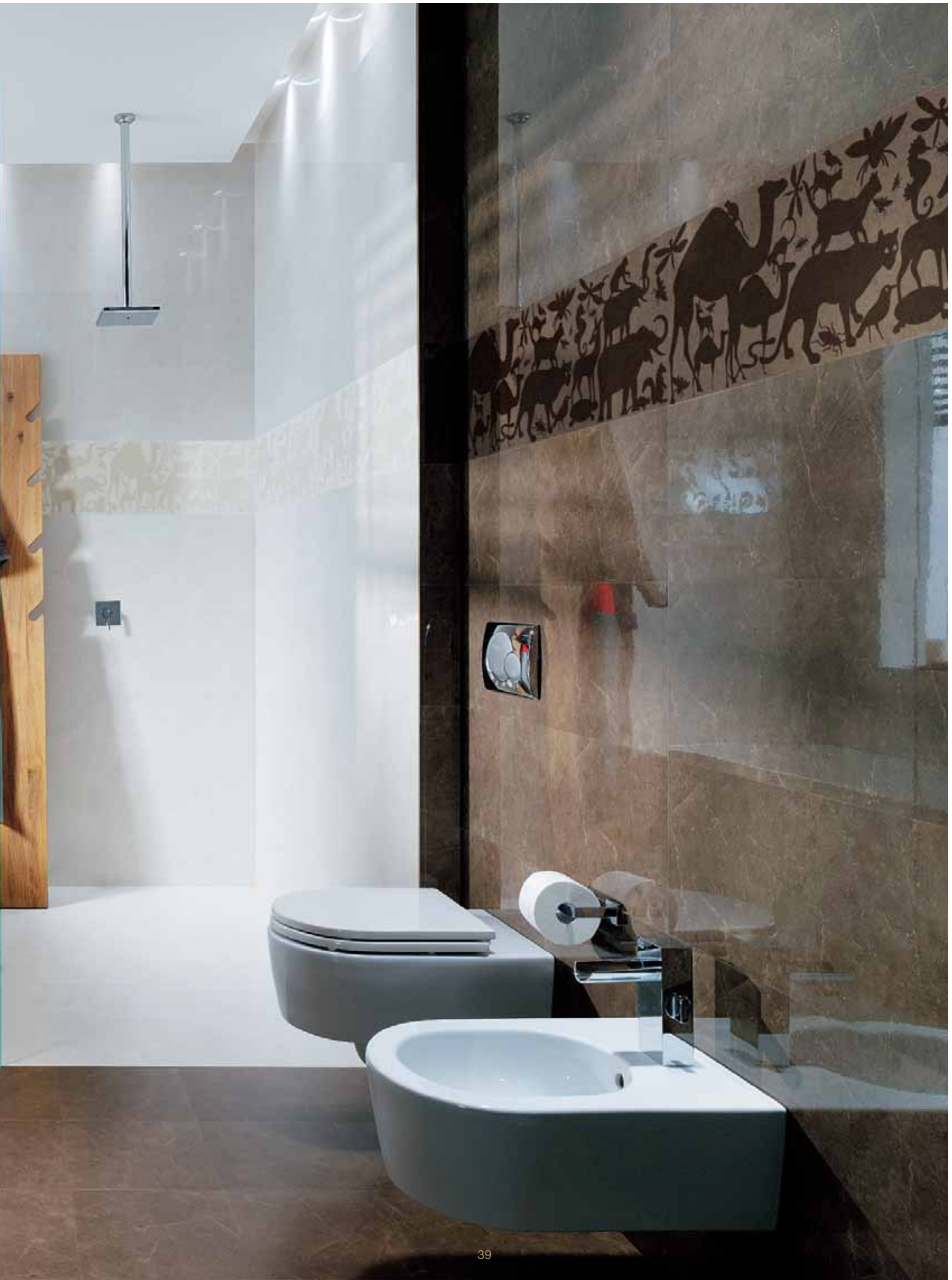

# oh!

Profumi di luoghi lontani. Riflessi che rinnovano il passato. Tracce inconfondibili di personalità. E la luce ricopre di attenzioni ogni più piccolo dettaglio rivelando la particolarità del tocco. Oh!

The scents of distant lands. Touches harking back to the past. Marked by unmistakable flair. Light brings attention to all the tiniest details, revealing a special touch. Oh! / Düfte ferner Länder. Reflexe, die Traditionen wieder aufleben lassen. Unverwechselbare Spuren der Persönlichkeit. Und das Licht verleiht jedem Detail die notwendige Aufmerksamkeit und enthüllt einen besonderen Touch. Oh! / Des parfums venus de loin. Des reflets qui raniment le passé. Les témoignages incomparables d'individualités. Une lumière qui comble d'attentions les plus petits détails, révélant la spécificité de l'aspect. Oh! / Perfumes de tierras lejanas. Reflejos que renuevan el pasado. Rastros inconfundibles de personalidad. Y la luz cubre de atenciones cada pequeño detalle revelando la particularidad del estilo. Oh! / Ароматы далеких стран. Отблески прошлого. Отличительные черты индивидуальности. И свет, наполняющий атмосферу уютom, подчеркивает особенность каждого элемента и декора. Oh!











Wall:  
Oh! Dorato Classico 30,5x91,5 RT  
Oh! Marrone Profondo 30,5x91,5 RT  
Oggi Beige Marrone Inserto 30,5x91,5 RT

Floor:  
Oh! Marrone Profondo 30,5x30,5 RT

TonosuTono:  
TonosuTono 02 Gesso  
TonosuTono 14 Marrone

Project on page 93





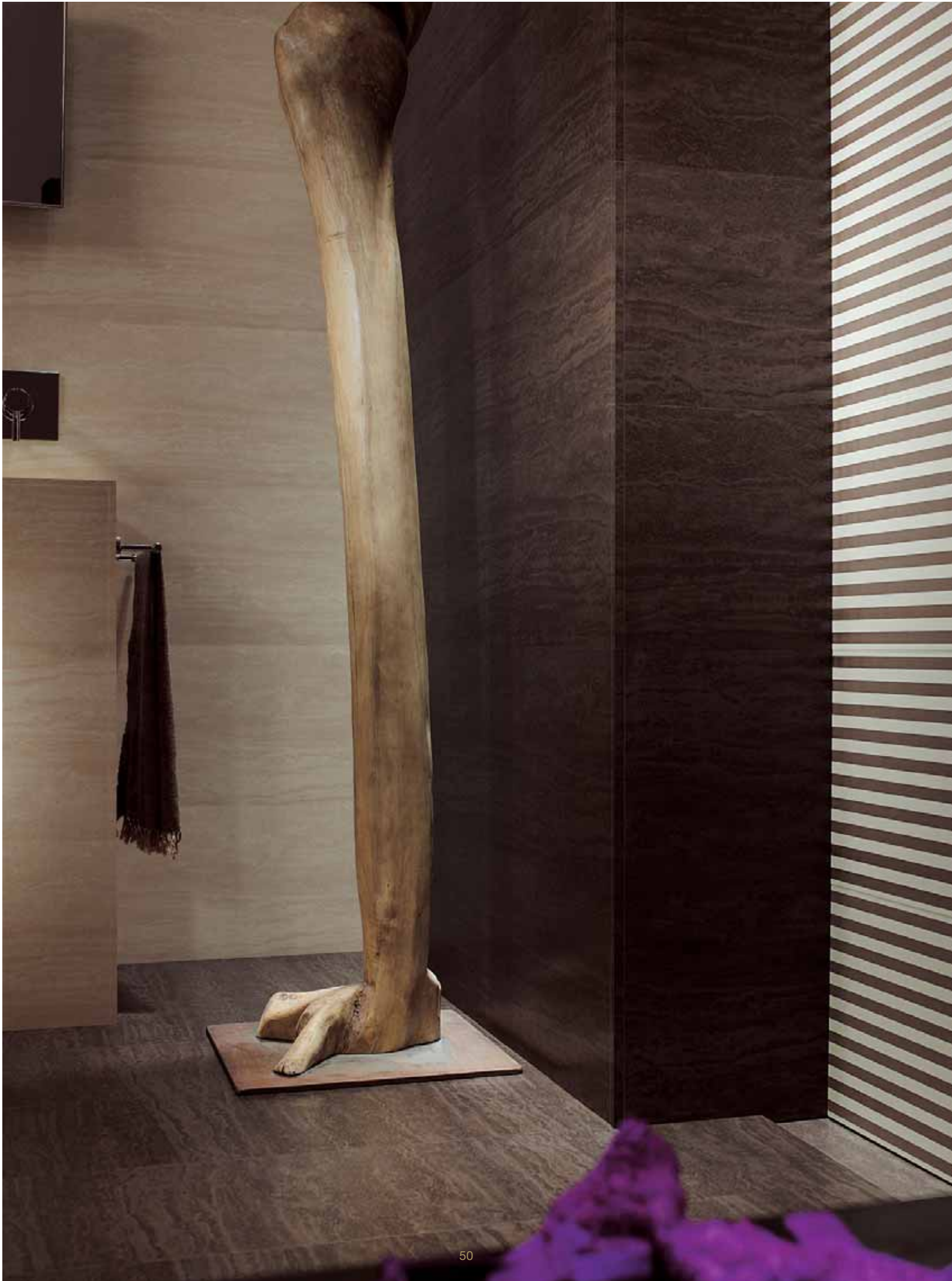



Wall:  
Oh! Rosa Incanto 30,5x91,5 RT  
Oh! Rosa Mosaico 30,5x30,5  
Opera Rosa Inserto Mix 3 91,5x91,5 RT  
Variazione+ Mensola 91x14x12

Floor:  
Oh! Rosa Incanto 30,5x30,5 RT

TonosuTono:  
TonosuTono 15 Magnolia

Project on page 94





# oh!

Citazioni di tempi passati, uniche, esclusive e di valore. Presenze che rivelano emozioni, ma anche i lati più umani della personalità. Mentre la passione tinge dei suoi colori tutto ciò che incontra. Oh!

Exclusive references to the finery of time gone by. These touches infuse spaces with emotive impact and a human character. The colors of passion wash over everything they touch. Oh! / Einzigartige, exklusive und kostbare Zitate aus vergangenen Zeiten. Präsenzen, die Gefühle, aber auch die menschlichen Seiten des Charakters, enthüllen. Während die Leidenschaft, allem, was sie berührt, ihre Farben verleiht. Oh! / Des emprunts d'antan, uniques, exclusifs et précieux. Autant de présences qui révèlent des émotions mais aussi le côté le plus humain de la personnalité. La passion, elle, teinte de ses couleurs tout ce qu'elle touche. Oh! / Citas del pasado, únicas, exclusivas y de valor. Presencias que revelan emociones, pero también los lados más humanos de la personalidad. Mientras la pasión tinte con sus colores todo aquello que encuentra. Oh! / Воспоминания о прошлом, уникальные, эксклюзивные, ценные. Их присутствие вызывает эмоции, подчеркивает самые гуманные черты личности. А страсть ярко расцветивает все, что встречается ей на пути. Oh!



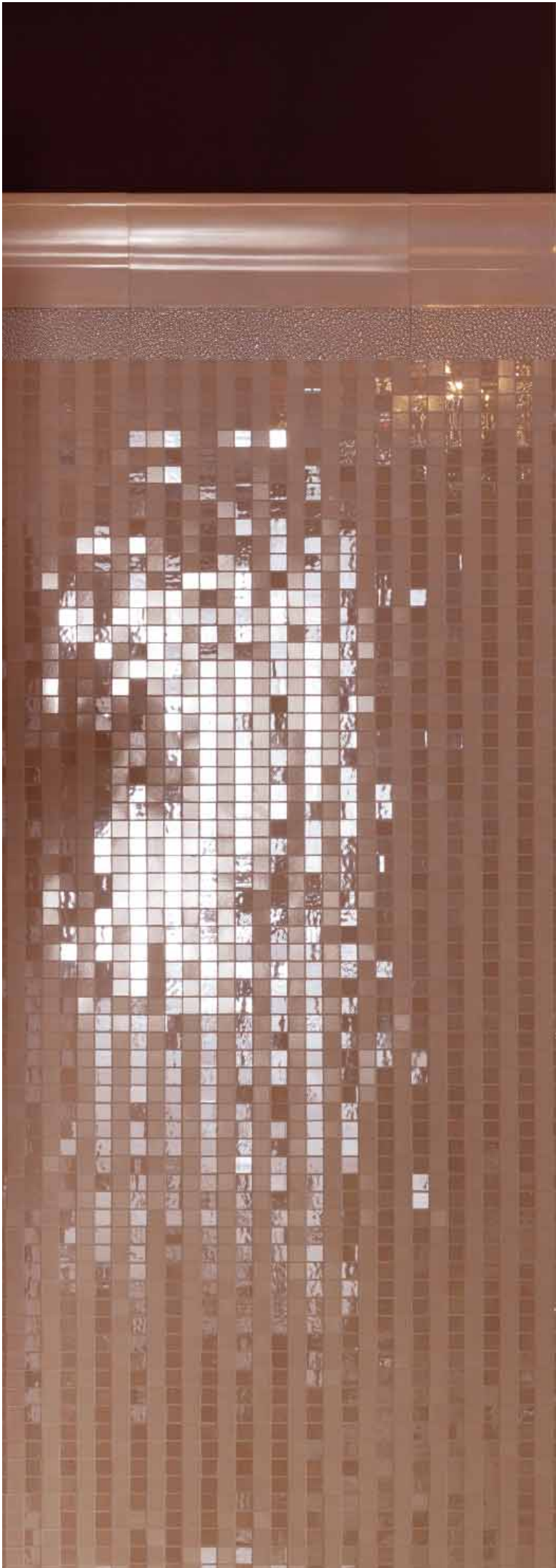

# oh!

Impossessarsi di uno spazio esclusivo ed invaderlo con ogni mezzo, per affermare, con fermezza, la propria essenza. Disordine ed equilibrio. Bellezza ed ironia. Controsensi ed imprevisti. Espressione di un modo, assolutamente personale, di intendere la vita.

Take over an exclusive space and use every mean to unequivocally state its true nature. Disorder and balance. Beauty and irony. The absurd and unexpected. Expressing a completely personal way of seeing life. / Einen ganz exklusiven Raum in Besitz nehmen und diesen mit allen Mitteln einnehmen, um mit Bestimmtheit seine eigene Essenz zu behaupten. Unordnung und Gleichgewicht. Schönheit und Spiel. Gegensätze und Unvorhergesehenheiten. Ausdruck einer ganz persönlichen Art, das Leben zu verstehen. / Prendre possession d'un espace exclusif et l'envahir par tous les moyens, pour affirmer son essence, avec fermeté. Désordre et équilibre. Beauté et ironie. D'égaréments en imprévus. Expression d'une manière, tout à fait personnelle, de voir la vie. / Adueñarse de un espacio exclusivo e invadirlo con cualquier medio, para sostener, con firmeza, la propia esencia. Desorden y equilibrio. Belleza e ironía. Contrasentidos e imprevistos. Expresión de un modo, absolutamente personal, de entender la vida. / Овладеть эксклюзивным пространством и захватить его всеми средствами, чтобы решительно утвердить свое Я. Беспорядок и гармония. Красота и ирония. Противоречия и непредвиденности. Совершенно индивидуальное понимание жизни.



Il tuo bagno,  
la tua casa.

# oggi!

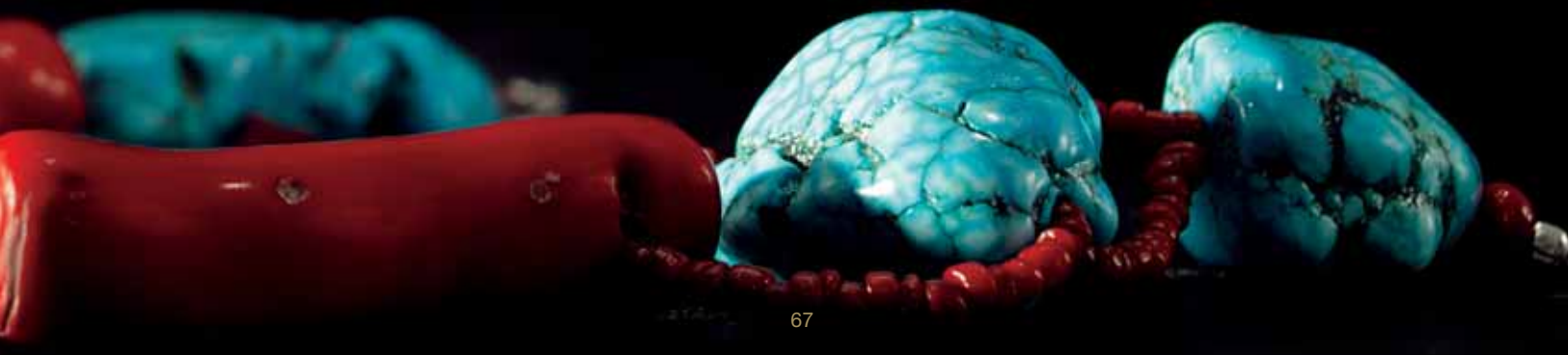





Wall:  
Oh! Vulcano 30,5x91,5 RT  
Oh! Grigio Classico 30,5x91,5 RT  
Oggi Bianco Nero Inserto 30,5x91,5 RT  
Oggi Bianco Nero Listello 9,5x30,5 RT

Floor:  
Oh! Vulcano 30,5x30,5 RT

TonosuTono:  
TonosuTono 01 Bianco  
TonosuTono 12 Nero

Project on page 95















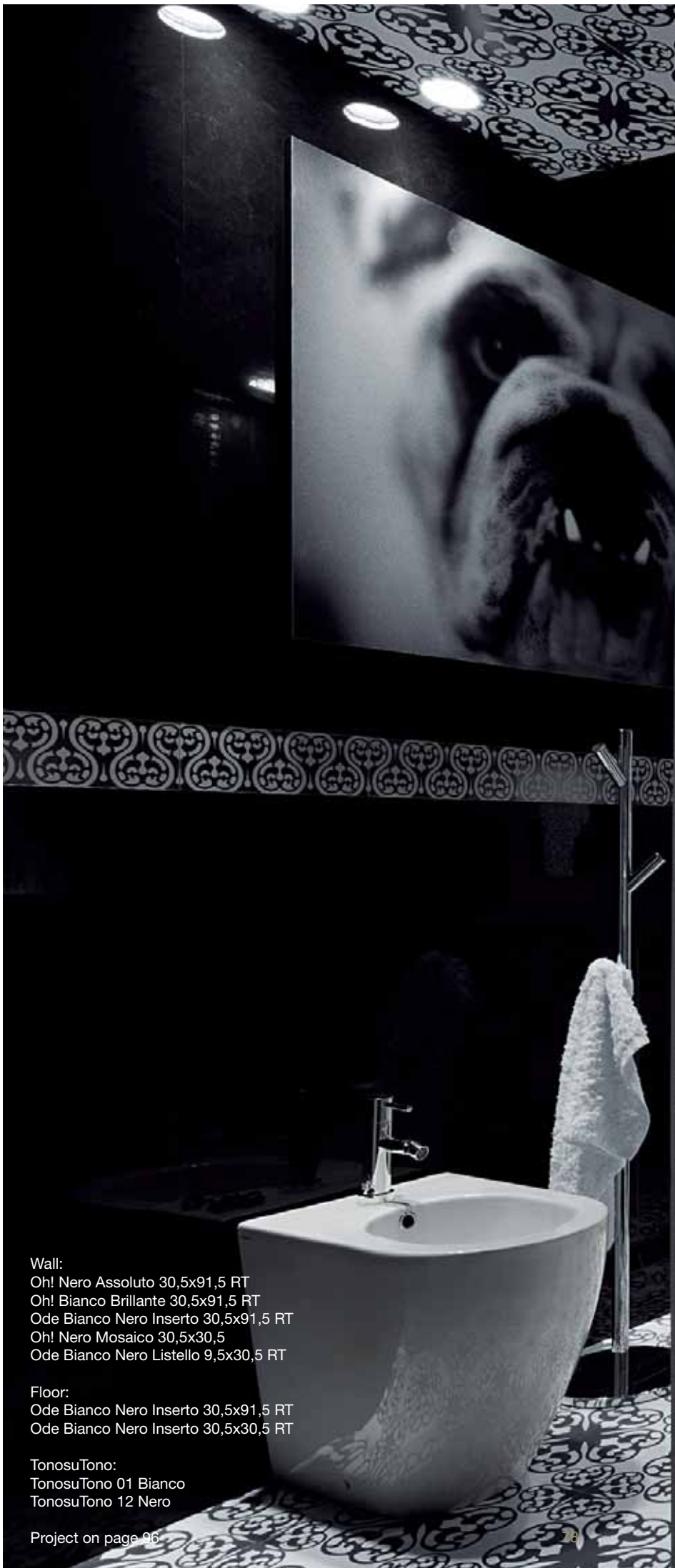

Wall:  
Oh! Nero Assoluto 30,5x91,5 RT  
Oh! Bianco Brillante 30,5x91,5 RT  
Ode Bianco Nero Inserto 30,5x91,5 RT  
Oh! Nero Mosaico 30,5x30,5  
Ode Bianco Nero Listello 9,5x30,5 RT

Floor:  
Ode Bianco Nero Inserto 30,5x91,5 RT  
Ode Bianco Nero Inserto 30,5x30,5 RT

TonosuTono:  
TonosuTono 01 Bianco  
TonosuTono 12 Nero















**listello onda**  
vibrazioni di luce sulle pareti del bagno.

vibrant light for your bathroom walls. / vibrierende Lichtreflexe auf den Wänden Ihres Bads. / des vibrations de lumière sur les murs de votre salle de bains. / vibraciones de luz en las paredes del cuarto de baño. / переливы света на стенах ванной комнаты.



**elemento modulare cubo**  
la componibilità è diventata arte.

modularity becomes an art form. / die Zusammenstellbarkeit ist zur Kunst geworden. / la modularité est désormais un art. / la modularidad hecha arte. компоновка стала искусством.

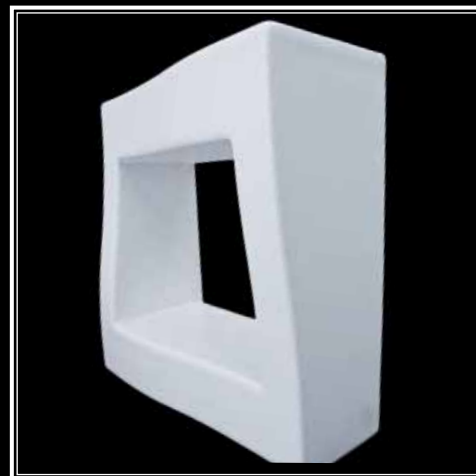

**mensola cubo**  
forme seducenti per arredare lo spazio.

appealing shapes decorate your space. / verführerische Formen, um den Raum einzurichten. / des formes séduisantes pour aménager l'espace. / formas seductoras para decorar el espacio. / привлекательные формы для обстановки пространства.





Wall A

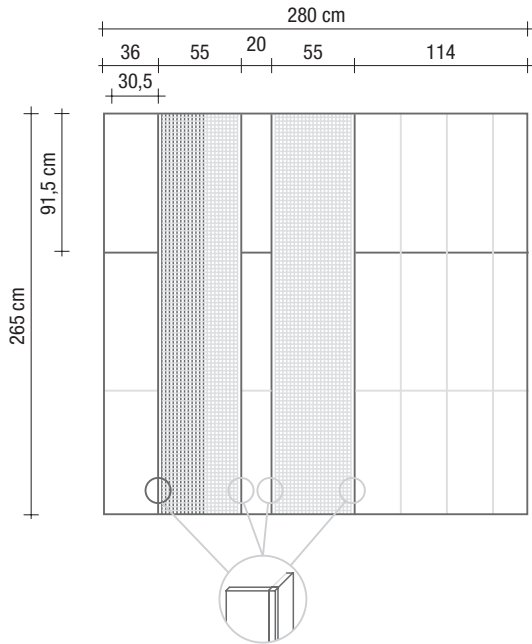

Wall B

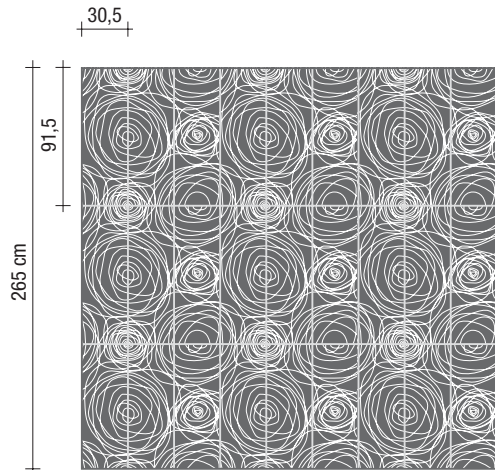

A

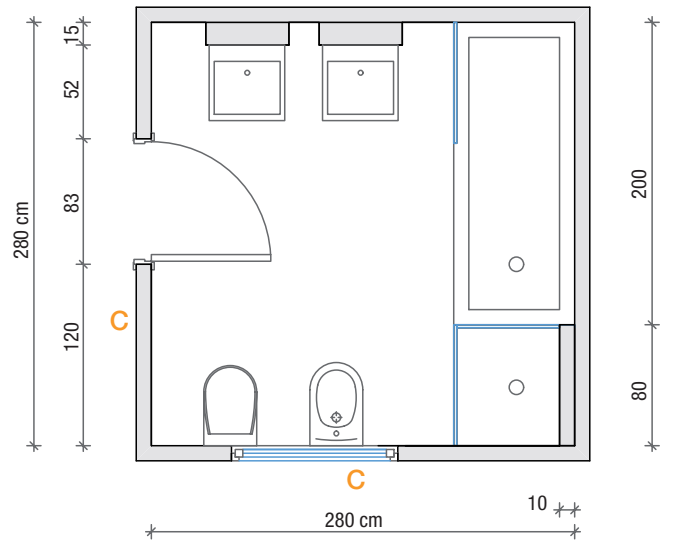

Wall C

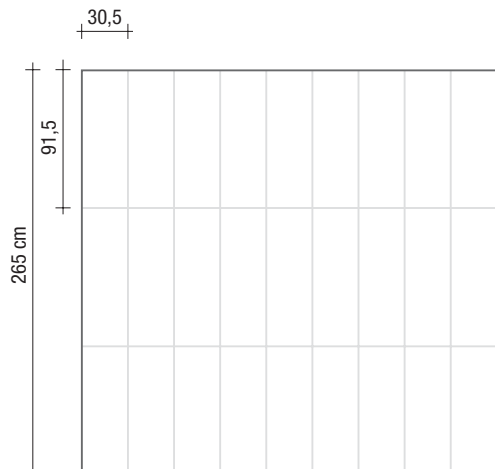

Wall A

- Oh! Oriente Beige 30,5x91,5 RT
- Oh! Oriente Terra 30,5x91,5 RT
- Opera Marrone Inserto Mix 3 91,5x91,5 RT
- Oh! Marrone Mosaico 30,5x30,5
- Gessato Oro Mosaico 30,5x30,5

Floor

- Evoluta Tweed 30,5x30,5 RT

TonosuTono

- TonosuTono 02 Gesso
- TonosuTono 16 Tabacco

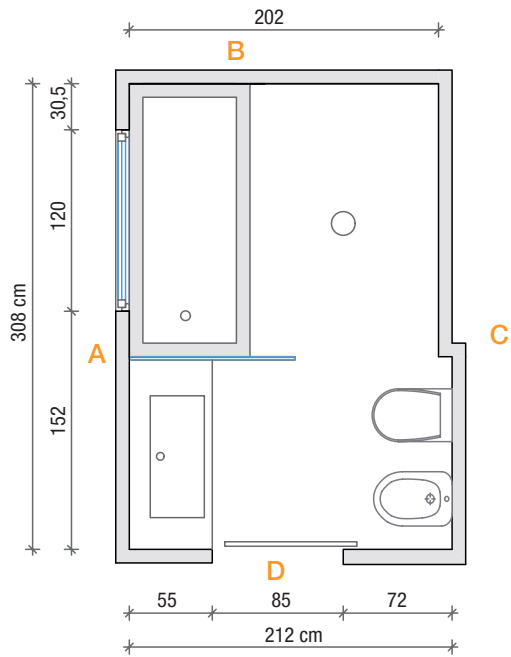

**Wall A**

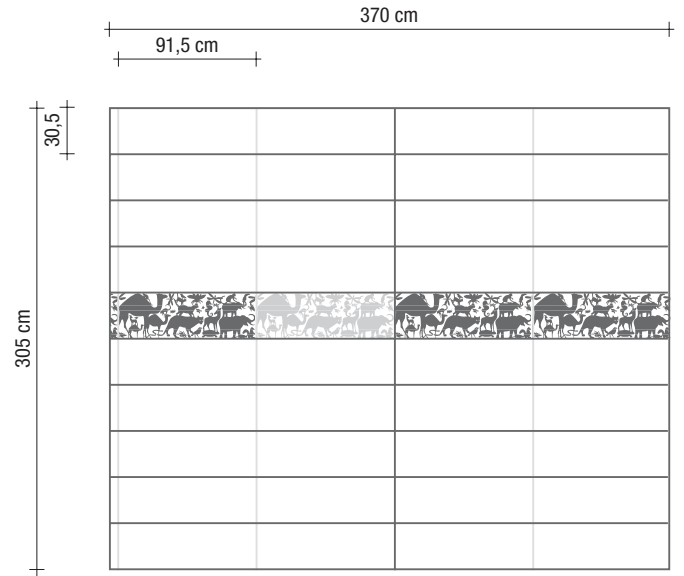

**Wall B**

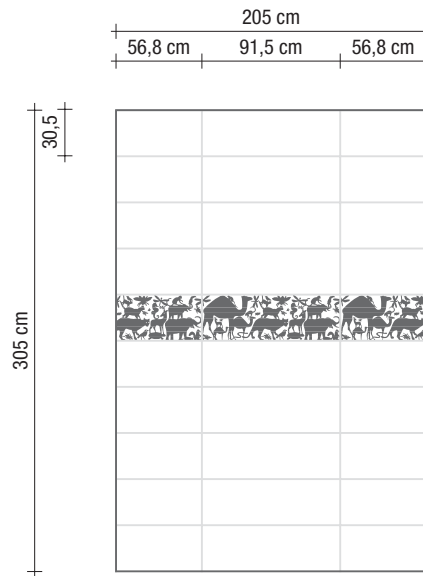

**Wall C**

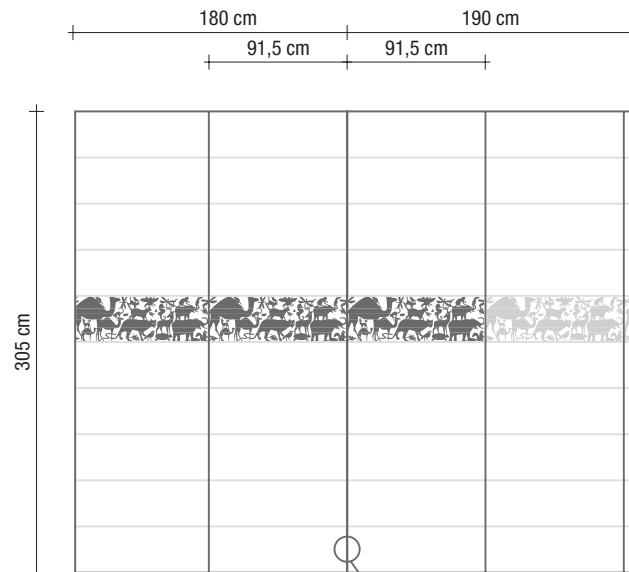

**Wall D**

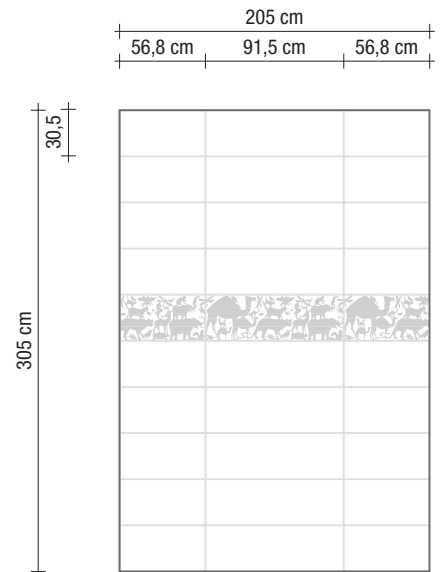

**Wall A**

- Oh! Oriente Terra 30,5x91,5 RT
- Oh! Oriente Grigio 30,5x91,5 RT
- Orma Grigio Inserto 30,5x91,5 RT
- Orma Marrone Inserto 30,5x91,5 RT

**Floor**

- Evoluta Tweed 30,5x30,5 RT
- Renova Grigio Perla 30,5x30,5 RT

**TonosuTono**

- Tonosutono 16 Tabacco
- Tonosutono 01 Bianco





**Wall A**

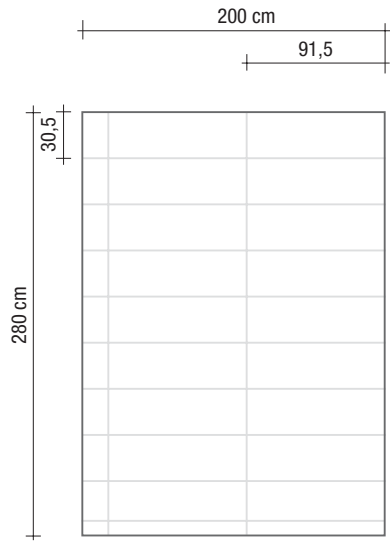

**Wall B**

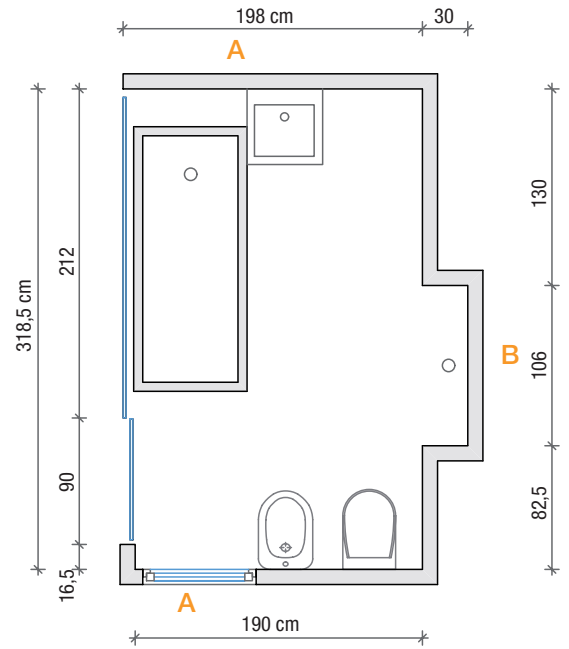
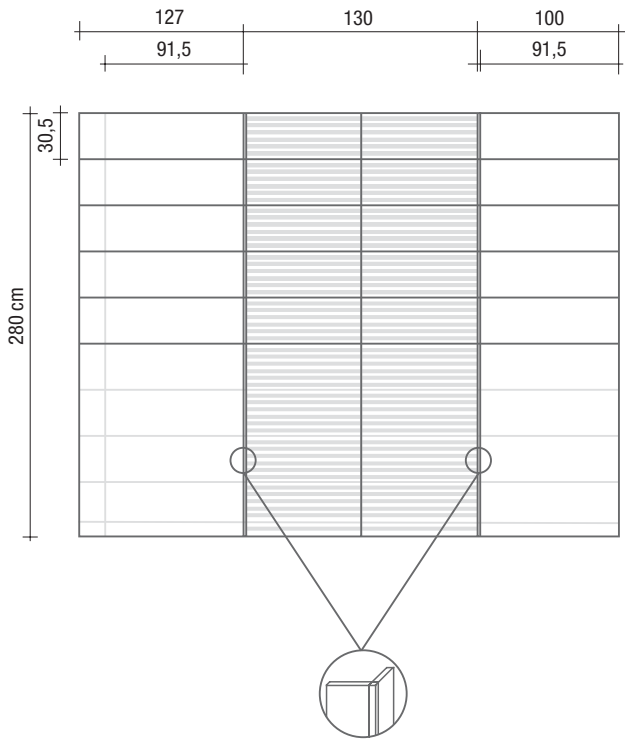

**Vasca**

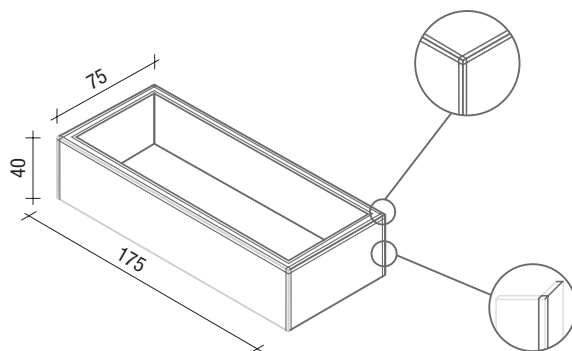

**Wall**

- Oh! Dorato Classico 30,5x91,5 RT
- Oh! Marrone Profondo 30,5x91,5 RT
- Oggi Beige Marrone Inserto 30,5x91,5 RT

**Floor**

- Oh! Marrone Profondo 30,5x30,5 RT

**TonosuTono**

- TonosuTono 02 Gesso
- TonosuTono 14 Marrone



**B**

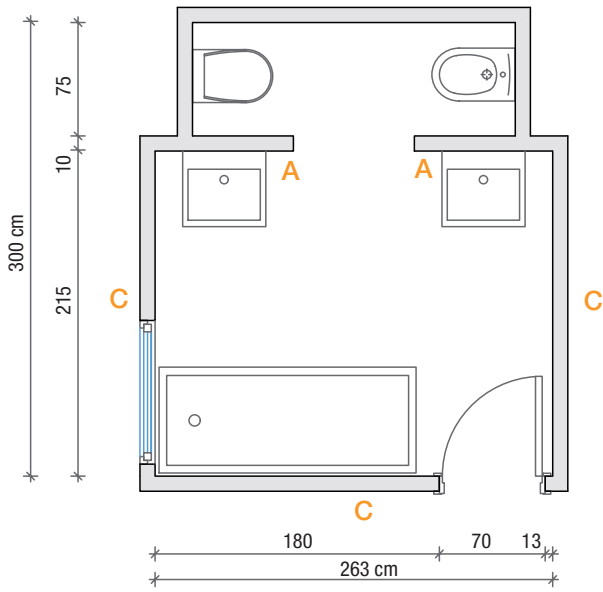

**Wall A**

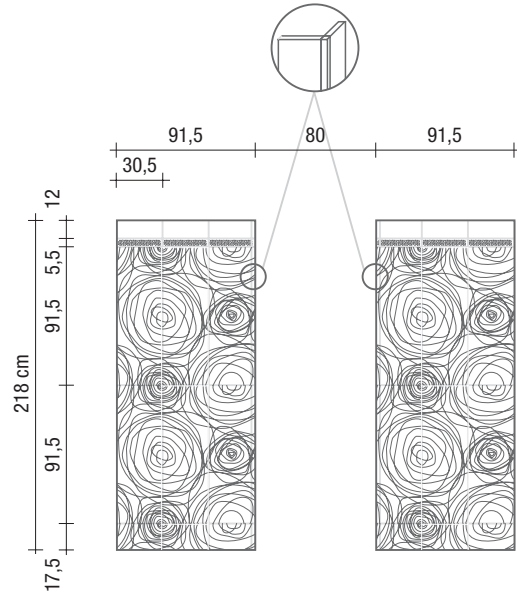

**Wall B**

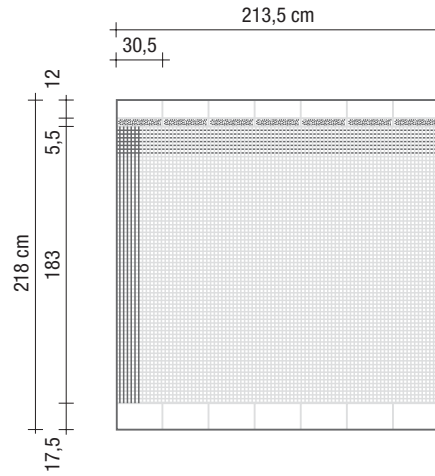

**Wall C**

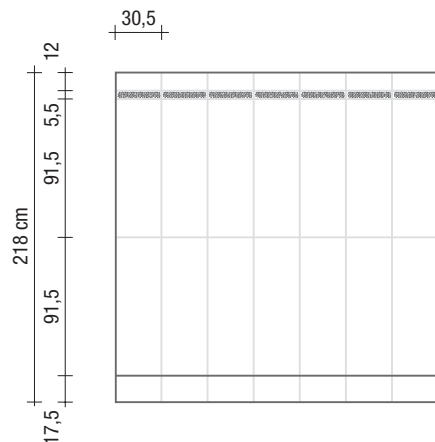

**Wall**

- Oh! Rosa Incanto 30,5x91,5 RT
- Oh! Rosa Mosaico 30,5x30,5
- Opera Rosa Inserto Mix 3 91,5x91,5 RT

**Floor**

- Oh! Rosa Incanto 30,5x30,5 RT

**TonosuTono**

- TonosuTono 15 Magnolia



Wall A

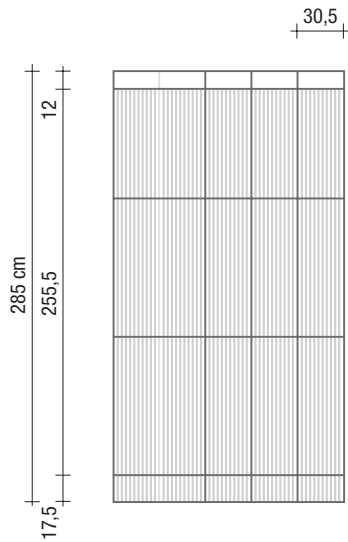

Wall B

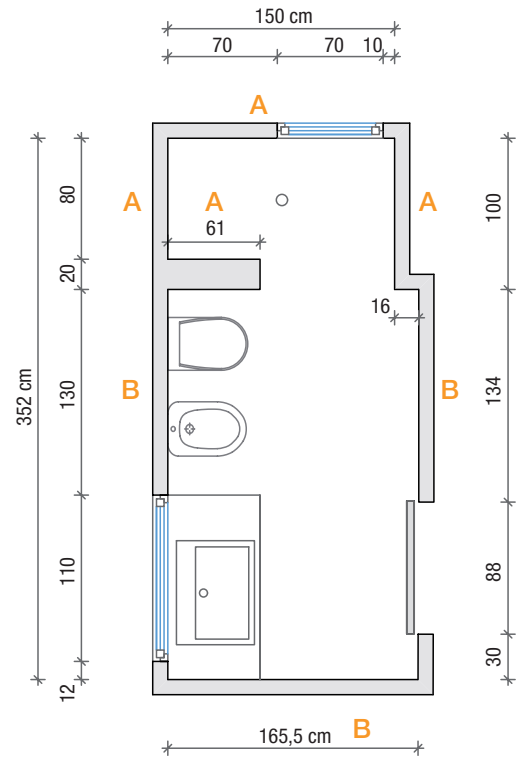
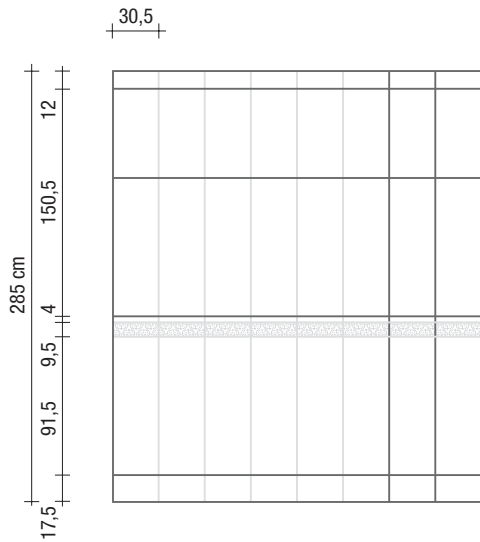

- Wall**
- Oh! Vulcano 30,5x91,5 RT
  - Oh! Grigio Classico 30,5x91,5 RT
  - Oggi Bianco Nero Inserto 30,5x91,5 RT
  - Oggi Bianco Nero Listello 9,5x30,5 RT

- Floor**
- Oh! Vulcano 30,5x30,5 RT

- TonosuTono**
- TonosuTono 01 Bianco
  - TonosuTono 12 Nero

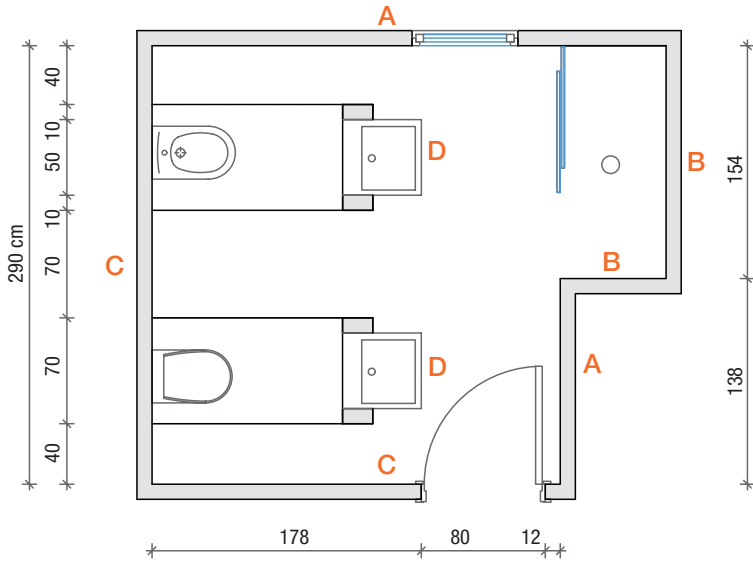
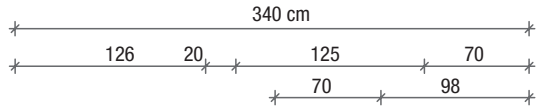

Wall A

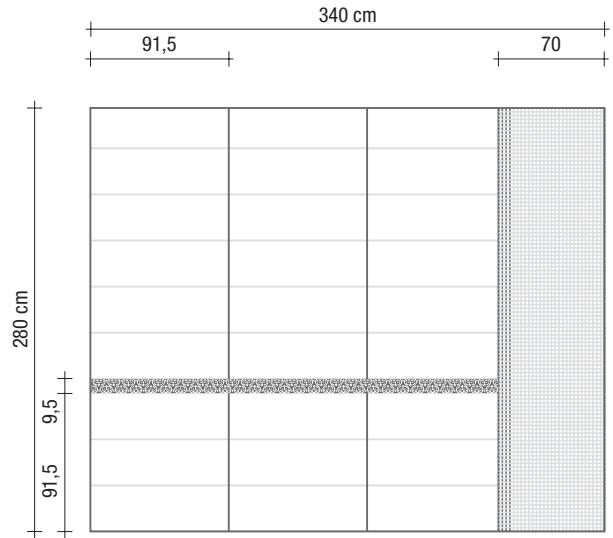

Wall B

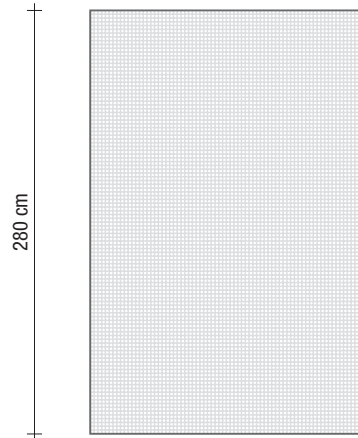

Wall C

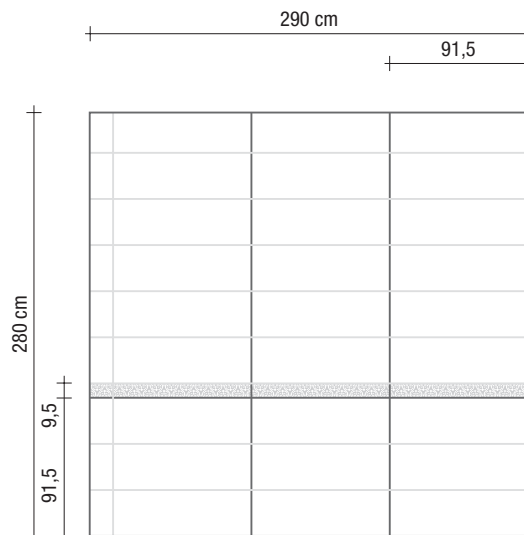

Wall D

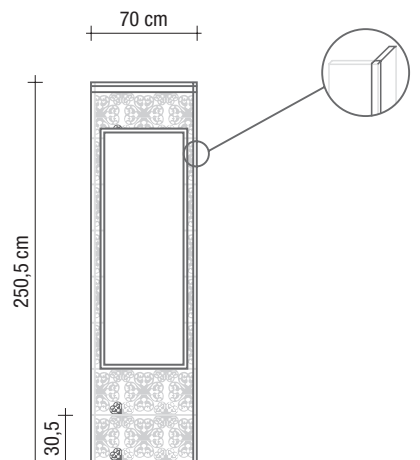

Wall

- Oh! Nero Assoluto 30,5x91,5 RT
- Oh! Bianco Brillante 30,5x91,5 RT
- Ode Bianco Nero Inserto 30,5x91,5 RT
- Oh! Nero Mosaico 30,5x30,5
- Ode Bianco Nero Listello 9,5x30,5 RT

Floor

- Ode Bianco Nero Inserto 30,5x91,5 RT
- Ode Bianco Nero Inserto 30,5x30,5 RT

TonosuTono

- TonosuTono 01 Bianco
- TonosuTono 12 Nero



**RT / rettificato**  
**rectified - begradigt - rectifie - rectificado - ректифицированная**

**RIVESTIMENTI** WALL TILES - WANDFLIESEN  
 REVETEMENTS - REVESTIMIENTOS - ОБЛИЦОВОЧНАЯ ПЛИТКА

**PASTA BIANCA** WHITE BODY - WEISSCHERBIGER  
 PÂTE BLANCHE - PASTA BLANCA - БЕЛАЯ ГЛИНА

**30,5x91,5**  
 12"x36"

**RT**

**SPESSORE 11,5 mm**  
 THICKNESS - STÄRKE - ÉPAISSEUR - ESPESOR - ТОЛЩИНА



Marrone Profondo  
 30,5x91,5 RT  
 TonosuTono 14 MARRONE



Marrone  
 London 4x30,5 RT



A.E.  
 London  
 2,5x4



Marrone Profondo  
 Spigolo 1,5x30,5 RT



A.E.  
 Spigolo  
 1,5x1,5



Beige  
 London 4x30,5 RT



A.E.  
 London  
 2,5x4



Dorato Classico  
 Spigolo 1,5x30,5 RT



A.E.  
 Spigolo  
 1,5x1,5



Dorato Classico  
 30,5x91,5 RT  
 TonosuTono 02 GESSO

**PAVIMENTI** FLOOR TILES - BODENFLIESEN  
 SOLS - PAVIMENTOS - НАПОЛЬНАЯ ПЛИТКА

**GRES PORCELLANATO** PORCELAIN - FEINSTEINZEUG  
 GRES CERAME - GRES PORCELÁNICO - КЕРАМОГРАНИТ

**30,5x30,5**  
 12"x12"

**RT**

**SPESSORE 8,6 mm**  
 THICKNESS - STÄRKE - ÉPAISSEUR - ESPESOR - ТОЛЩИНА



Marrone Profondo  
 30,5x30,5 RT  
 TonosuTono 14 MARRONE

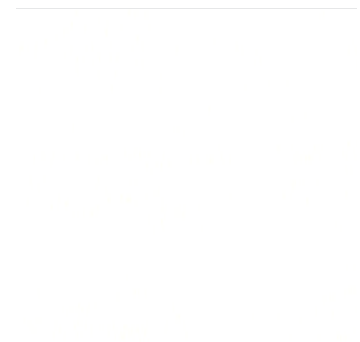

Renova Travertino Dorato  
 30,5x30,5 RT  
 TonosuTono 02 GESSO



Grigio Classico  
30,5x91,5 RT  
TonosuTono 01 BIANCO



Grigio  
London 4x30,5 RT



A.E.  
London  
2,5x4



Grigio Classico  
Spigolo 1,5x30,5 RT



A.E.  
Spigolo  
1,5x1,5



Vulcano  
30,5x91,5 RT  
TonosuTono 12 NERO



Nero  
London 4x30,5 RT



A.E.  
London  
2,5x4



Vulcano  
Spigolo 1,5x30,5 RT



A.E.  
Spigolo  
1,5x1,5



Renova Grigio Perla  
30,5x30,5 RT  
TonosuTono 01 BIANCO



Vulcano  
30,5x30,5 RT  
TonosuTono 12 NERO



**RT / rettificato**  
**rectified - begradigt - rectifie - rectificado - ректифицированная**

**RIVESTIMENTI** WALL TILES - WANDFLIESEN  
 REVESTIMIENTOS - REVESTIMIENTOS - ОБЛИЦОВОЧНАЯ ПЛИТКА

**PASTA BIANCA** WHITE BODY - WEISSCHERBIGER  
 PÂTE BLANCHE - PASTA BLANCA - БЕЛАЯ ГЛИНА

**30,5x91,5**  
 12"x36"

**RT**

**SPESSORE 11,5 mm**  
 THICKNESS - STÄRKE - ÉPAISSEUR - ESPESOR - ТОЛЩИНА



Oriente Terra  
 30,5x91,5 RT  
 TonosuTono 16 TABACCO



Terra  
 London 4x30,5 RT



A.E.  
 London  
 2,5x4



Oriente Terra  
 Spigolo 1,5x30,5 RT



A.E.  
 Spigolo  
 1,5x1,5



Beige  
 London 4x30,5 RT



A.E.  
 London  
 2,5x4



Oriente Beige  
 Spigolo 1,5x30,5 RT



A.E.  
 Spigolo  
 1,5x1,5



Oriente Beige  
 30,5x91,5 RT  
 TonosuTono 02 GESSO

**PAVIMENTI** FLOOR TILES - BODENFLIESEN  
 SOLS - PAVIMENTOS - НАПОЛЬНАЯ ПЛИТКА

**GRES PORCELLANATO** PORCELAIN - FEINSTEINZEUG  
 GRES CERAME - GRES PORCELÁNICO - КЕРАМОГРАНИТ

**30,5x30,5**  
 12"x12"

**RT**

**SPESSORE 8,6 mm**  
 THICKNESS - STÄRKE - ÉPAISSEUR - ESPESOR - ТОЛЩИНА



Evoluta Tweed  
 30,5x30,5 RT  
 TonosuTono 16 TABACCO



Evoluta Cashmere  
 30,5x30,5 RT  
 TonosuTono 02 GESSO



Bianco Brillante  
30,5x91,5 RT  
TonosuTono 01 BIANCO



Bianco  
London 4x30,5 RT



A.E.  
London  
2,5x4



Bianco Brillante  
Spigolo 1,5x30,5 RT



A.E.  
Spigolo  
1,5x1,5



Nero  
London 4x30,5 RT



A.E.  
London  
2,5x4



Nero Assoluto  
Spigolo 1,5x30,5 RT



A.E.  
Spigolo  
1,5x1,5



Nero Assoluto  
30,5x91,5 RT  
TonosuTono 12 NERO



Passion Carrara Bianco  
30,5x30,5 RT  
TonosuTono 01 BIANCO



Vulcano  
30,5x30,5 RT  
TonosuTono 12 NERO



**RT / rettificato**  
**rectified - begradigt - rectifie - rectificado - ректифицированная**

**RIVESTIMENTI** WALL TILES - WANDFLIESEN  
 REVETEMENTS - REVESTIMIENTOS - ОБЛИЦОВОЧНАЯ ПЛИТКА

**PASTA BIANCA** WHITE BODY - WEISSCHERBIGER  
 PÂTE BLANCHE - PASTA BLANCA - БЕЛАЯ ГЛИНА

**30,5x91,5**  
 12"x36"

**RT**

**SPESSORE 11,5 mm**  
 THICKNESS - STÄRKE - ÉPAISSEUR - ESPESOR - ТОЛЩИНА



Rosa Incanto  
 30,5x91,5 RT  
 TonosuTono 15 MAGNOLIA



Rosa  
 London 4x30,5 RT



A.E.  
 London  
 2,5x4



Rosa Incanto  
 Spigolo 1,5x30,5 RT



A.E.  
 Spigolo  
 1,5x1,5



Grigio  
 London 4x30,5 RT



A.E.  
 London  
 2,5x4



Oriente Grigio  
 Spigolo 1,5x30,5 RT



A.E.  
 Spigolo  
 1,5x1,5



Oriente Grigio  
 30,5x91,5 RT  
 TonosuTono 01 BIANCO

**PAVIMENTI** FLOOR TILES - BODENFLIESEN  
 SOLS - PAVIMENTOS - НАПОЛЬНАЯ ПЛИТКА

**GRES PORCELLANATO** PORCELAIN - FEINSTEINZEUG  
 GRES CERAME - GRES PORCELÁNICO - КЕРАМОГРАНИТ

**30,5x30,5**  
 12"x12"

**RT**

**SPESSORE 8,6 mm**  
 THICKNESS - STÄRKE - ÉPAISSEUR - ESPESOR - ТОЛЩИНА



Rosa Incanto  
 30,5x30,5 RT  
 TonosuTono 15 MAGNOLIA



Evoluta Cotone  
 30,5x30,5 RT  
 TonosuTono 01 BIANCO

RT / rettificato

rectified - begradigt - rectifie - rectificado - ректифицированная

**RIVESTIMENTI** WALL TILES - WANDFLIESEN  
REVETEMENTS - REVESTIMIENTOS - ОБЛИЦОВОЧНАЯ ПЛИТКА

**PASTA BIANCA** WHITE BODY - WEISSCHERBIGER  
PÂTE BLANCHE - PASTA BLANCA - БЕЛАЯ ГЛИНА

**30,5x30,5**  
12"x12"

**RT**

**SPESSORE 11,5 mm**  
THICKNESS - STÄRKE - ÉPAISSEUR - ESPESOR - ТОЛЩИНА



Beige Mosaico\*  
30,5x30,5  
TonosuTono 02 GESSO

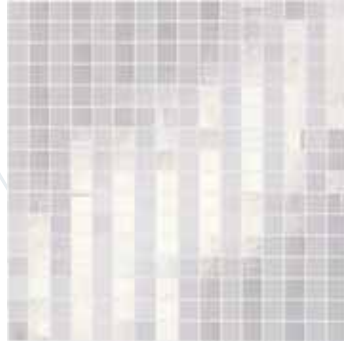

Bianco Mosaico\*  
30,5x30,5  
TonosuTono 01 BIANCO

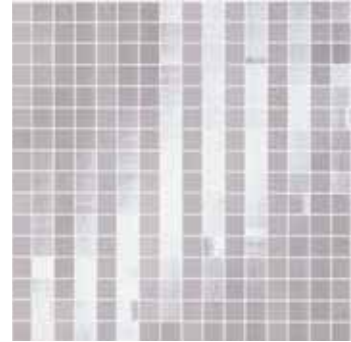

Grigio Mosaico\*  
30,5x30,5  
TonosuTono 01 BIANCO

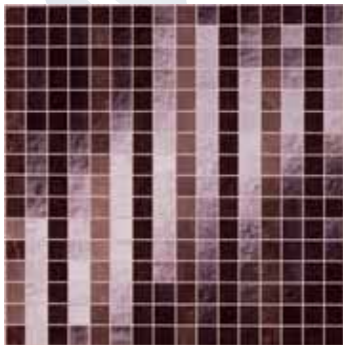

Marrone Mosaico\*  
30,5x30,5  
TonosuTono 14 MARRONE

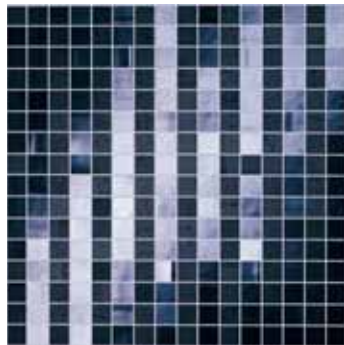

Nero Mosaico\*  
30,5x30,5  
TonosuTono 12 NERO



Rosa Mosaico\*  
30,5x30,5  
TonosuTono 15 MAGNOLIA

\* Formato tessera: 1,7x1,7 cm - Mosaic size: 1,7x1,7 cm - Mittelmosaik-Format: 1,7x1,7 cm - Petit format: 1,7x1,7 cm - Tamaño del mosaico: 1,7x1,7 cm. - Формат смальты: 1,7x1,7 см

\*\* Formato tessera: 2,2x2,2 cm - Mosaic size: 2,2x2,2 cm - Mittelmosaik-Format: 2,2x2,2 cm - Petit format: 2,2x2,2 cm - Tamaño del mosaico: 2,2x2,2 cm. - Формат смальты: 2,2x2,2 см



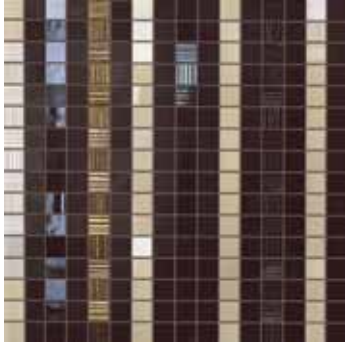

Gessato Oro Mosaico\*  
30,5x30,5  
TonosuTono 14 MARRONE



Oro Mosaico\*  
30,5x30,5  
TonosuTono 02 GESSO

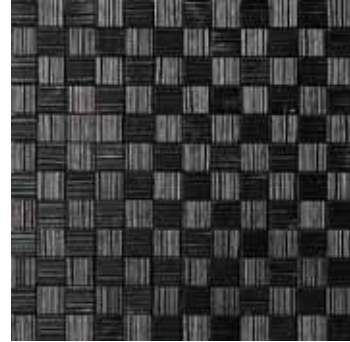

Stream Mosaico\*\*  
30,5x30,5  
TonosuTono 12 NERO



Nero Rombi Mosaico\*  
30,5x30,5  
TonosuTono 12 NERO



Beige Rombi Mosaico\*  
30,5x30,5  
TonosuTono 02 GESSO

# RT / rettificato

rectified - begradigt - rectifie - rectificado - ректифицированная

**RIVESTIMENTI** WALL TILES - WANDFLIESEN  
REVETEMENTS - REVESTIMIENTOS - ОБЛИЦОВОЧНАЯ ПЛИТКА

**PASTA BIANCA** WHITE BODY - WEISSCHERBIGER  
PÂTE BLANCHE - PASTA BLANCA - БЕЛАЯ ГЛИНА

**30,5x91,5**  
12"x36"

**RT**

**SPESSORE 11,5 mm**

THICKNESS - STÄRKE - ÉPAISSEUR - ESPESOR - ТОЛЩИНА



Bianco Brillante  
Raccordo  
2,5x30,5 RT



Bianco  
A.E. Alzata  
2,5x17,5 RT

Bianco  
A.Int. Alzata  
2x11



Bianco  
Capitello  
30,5x12 RT



Bianco  
A.E. Capitello  
2,5x12 RT



Bianco  
A.Int. Capitello  
2,5x10,5



Oriente Beige  
Raccordo  
2,5x30,5 RT



Oriente Beige  
A.E. Alzata  
2,5x17,5 RT

Oriente Beige  
A.Int. Alzata  
2x11



Oriente Beige  
Capitello  
30,5x12 RT



Oriente Beige  
A.E. Capitello  
2,5x12 RT



Oriente Beige  
A.Int. Capitello  
2,5x10,5



Grigio Classico  
Raccordo  
2,5x30,5 RT



Grigio  
A.E. Alzata  
2,5x17,5 RT

Grigio  
A.Int. Alzata  
2x11



Grigio  
Capitello  
30,5x12 RT



Grigio  
A.E. Capitello  
2,5x12 RT



Grigio  
A.Int. Capitello  
2,5x10,5



Oriente Terra  
Raccordo  
2,5x30,5 RT



Oriente Terra  
A.E. Alzata  
2,5x17,5 RT

Oriente Terra  
A.Int. Alzata  
2x11



Oriente Terra  
Capitello  
30,5x12 RT



Oriente Terra  
A.E. Capitello  
2,5x12 RT



Oriente Terra  
A.Int. Capitello  
2,5x10,5

# oh!



Rosa Incanto  
Raccordo  
2,5x30,5 RT

Rosa  
Alzata  
30,5x17,5 RT

Rosa  
A.E. Alzata  
2,5x17,5 RT

Rosa  
A.Int. Alzata  
2x11

Rosa  
Capitello  
30,5x12 RT

Rosa  
A.E. Capitello  
2,5x12 RT

Rosa  
A.Int. Capitello  
2,5x10,5



Marrone Prof.  
Raccordo  
2,5x30,5 RT

Marrone  
Alzata  
30,5x17,5 RT

Marrone  
A.E. Alzata  
2,5x17,5 RT

Marrone  
A.Int. Alzata  
2x11

Marrone  
Capitello  
30,5x12 RT

Marrone  
A.E. Capitello  
2,5x12 RT

Marrone  
A.Int. Capitello  
2,5x10,5



Nero Assoluto  
Raccordo  
2,5x30,5 RT

Nero  
Alzata  
30,5x17,5 RT

Nero  
A.E. Alzata  
2,5x17,5 RT

Nero  
A.Int. Alzata  
2x11

Nero  
Capitello  
30,5x12 RT

Nero  
A.E. Capitello  
2,5x12 RT

Nero  
A.Int. Capitello  
2,5x10,5



Oriente Grigio  
Raccordo  
2,5x30,5 RT

Dorato Classico  
Raccordo  
2,5x30,5 RT

Vulcano  
Raccordo  
2,5x30,5 RT



## Angolo interno Alzata

Outer corner Alzata. - Inneneckstück Alzata. - Angle rentrant Alzata. - Ángulo interior Alzata. - Внутренний угол Alzata.

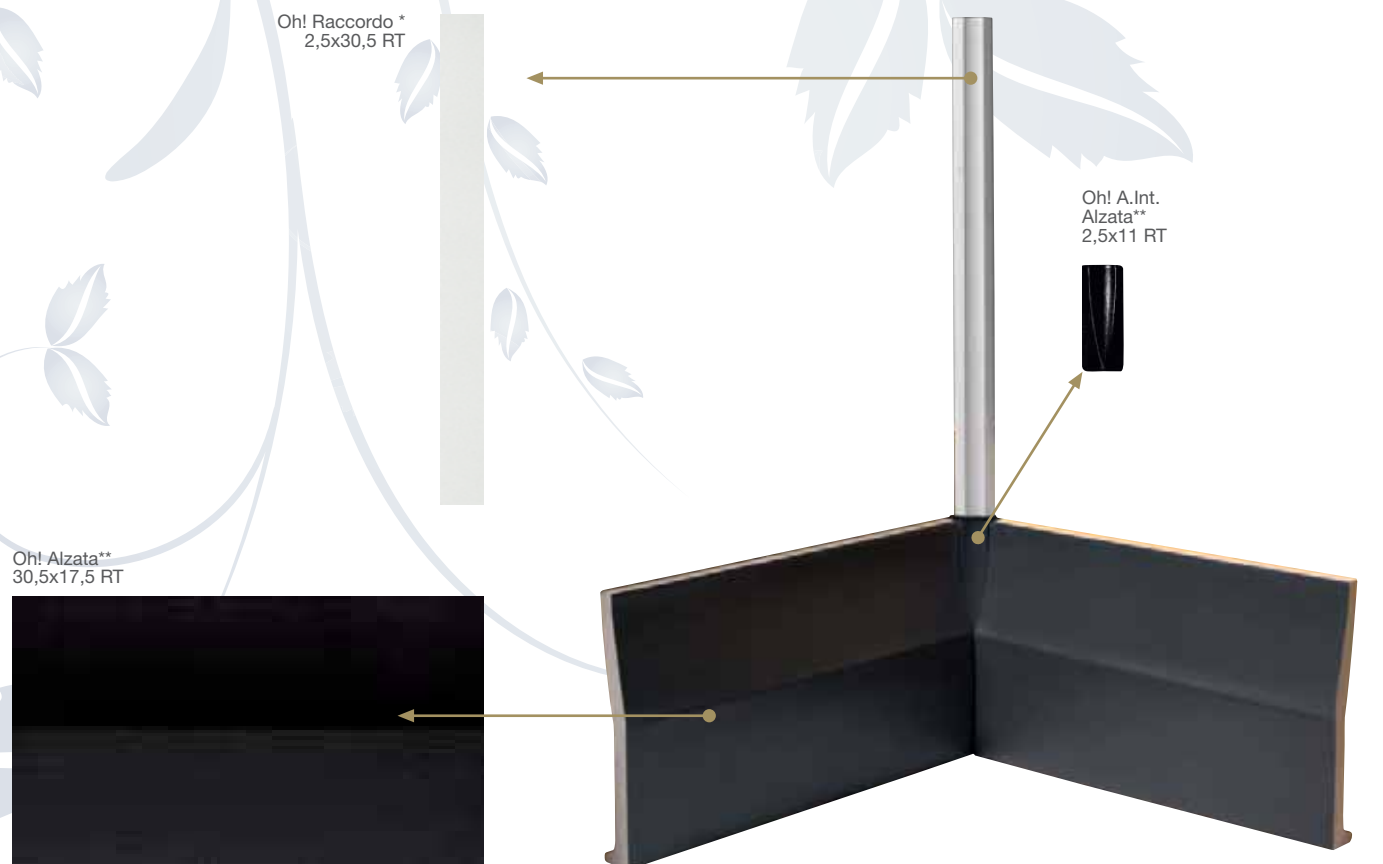

\* Disponibile in tutti i colori.  
Available in all colours  
In allen Farben erhältlich.  
Existe dans tous les coloris.  
Disponibile en todos los colores.  
Имеется в наличии во всех цветах.

\*\* Disponibile solo nei 7 colori:  
Available only in the 7 colours:  
Nur in den beiden folgenden Farben erhältlich:  
Existe seulement en 7 coloris:  
Disponibile sólo en 7 colores:  
Имеется в наличии только в 7-х цветах:  
Bianco - Marrone - Beige - Nero - Grigio - Rosa - Tortora.

## Angolo interno Capitello

Inner corner Capitello. - Inneneckstück Capitello. - Angle rentrant Capitello. - Ángulo interior Capitello. - Внутренний угол Capitello.



Oh! A.Int.  
Capitello\*\*  
2,5x10,5 RT

Oh! Capitello\*\*  
30,5x12 RT

Oh! Raccordo\*  
2,5x30,5 RT



\* Disponibile in tutti i colori.  
Available in all colours  
In allen Farben erhältlich.  
Existe dans tous les coloris.  
Disponibile en todos los colores.  
Имеется в наличии во всех цветах.

\*\* Disponibile solo nei 7 colori:  
Available only in the 7 colours:  
Nur in den beiden folgenden Farben erhältlich:  
Existe seulement en 7 coloris:  
Disponibile sólo en 7 colores:  
Имеется в наличии только в 7-х цветах:  
Bianco - Marrone - Beige - Nero - Grigio - Rosa - Tortora.

**RT / rettificato**  
rectified - begradigt - rectifie - rectificado - ректифицированная

**RIVESTIMENTI** WALL TILES - WANDFLIESEN  
REVETEMENTS - REVESTIMIENTOS - ОБЛИЦОВОЧНАЯ ПЛИТКА

**PASTA BIANCA** WHITE BODY - WEISSCHERBIGER  
PÂTE BLANCHE - PASTA BLANCA - БЕЛАЯ ГЛИНА

**30,5x91,5**  
12"x36"

**RT**

**SPESSORE 11,5 mm**  
THICKNESS - STÄRKE - ÉPAISSEUR - ESPESOR - ТОЛЩИНА



Opera Marrone Inserto Mix 3 91,5x91,5 RT  
TonosuTono 16 TABACCO



Drops Marrone Listello 5,5x30,5 RT



Drops Rosa Listello 5,5x30,5 RT



Luce Beige Listello 5x30,5 RT



Luce Pesca Listello 5x30,5 RT





Opera Rosa Inserto Mix 3 91,5x91,5 RT  
TonosuTono 15 MAGNOLIA



Roma Bianco Listello 5,5x30,5 RT



Roma Duna Listello 5,5x30,5 RT



Roma Nero Listello 5,5x30,5 RT

**RT / rettificato**  
**rectified - begradigt - rectifie - rectificado - ректифицированная**

**RIVESTIMENTI** WALL TILES - WANDFLIESEN  
REVETEMENTS - REVESTIMIENTOS - ОБЛИЦОВОЧНАЯ ПЛИТКА

**PASTA BIANCA** WHITE BODY - WEISSCHERBIGER  
PÂTE BLANCHE - PASTA BLANCA - БЕЛАЯ ГЛИНА

**30,5x91,5**  
12"x36"

**RT**

**SPESSORE 11,5 mm**  
THICKNESS - STÄRKE - ÉPAISSEUR - ESPESOR - ТОЛЩИНА



Orma Grigio Inserto 30,5x91,5 RT  
TonosuTono 01 BIANCO



Orma Marrone Inserto 30,5x91,5 RT  
TonosuTono 16 TABACCO

RT / rettificato

rectified - begradigt - rectifie - rectificado - ректифицированная

RIVESTIMENTI WALL TILES - WANDFLIESEN  
REVETEMENTS - REVESTIMIENTOS - ОБЛИЦОВОЧНАЯ ПЛИТКА

PASTA BIANCA WHITE BODY - WEISSCHERBIGER  
PÂTE BLANCHE - PASTA BLANCA - БЕЛАЯ ГЛИНА

30,5x91,5  
12"x36"

RT

SPESSORE 11,5 mm  
THICKNESS - STÄRKE - ÉPAISSEUR - ESPESOR - ТОЛЩИНА



Ode Bianco Nero Inserto 30,5x91,5 RT  
TonosuTono 01 BIANCO



Ode Beige Inserto 30,5x91,5 RT  
TonosuTono 02 GESSO



Ode Rosa Inserto 30,5x91,5 RT  
TonosuTono 15 MAGNOLIA



Ode Bianco Nero Listello 9,5x30,5 RT  
TonosuTono 01 BIANCO



Ode Beige Listello 9,5x30,5 RT  
TonosuTono 02 GESSO



Ode Rosa Listello 9,5x30,5 RT  
TonosuTono 15 MAGNOLIA



Ode Bianco Nero Inserto Pavimento 30,5x30,5 RT  
TonosuTono 01 BIANCO





Oggi Beige Marrone Inserto 30,5x91,5 RT  
TonosuTono 02 GESSO



Oggi Bianco Nero Inserto 30,5x91,5 RT  
TonosuTono 01 BIANCO



Oggi Beige Marrone Listello  
9,5x30,5 RT  
TonosuTono 02 GESSO



Oggi Bianco Nero Listello  
9,5x30,5 RT  
TonosuTono 01 BIANCO

## Informazioni utili

Useful information. / Nützliche Informationen. / Informations utiles. / Información útil. / Полезная информация.

### Rivestimenti in pasta bianca

White body wall tiles / Weißscherbiger Wandfliesen / Revêtements en pâte blanche / Revestimientos en pasta blanca / Облицовочная плитка из белой глины

CARATTERISTICHE TECNICHE	TECHNICAL SPECIFICATIONS	TECHNISCHE EIGENSCHAFTEN	CARACTERISTIQUES TECHNIQUES	CARACTERÍSTICAS TÉCNICAS	ТЕХНИЧЕСКИЕ ХАРАКТЕРИСТИКИ	NORME STANDARDS NORMEN NORMES NORMAS НОРМЫ	VALORE PRESCRITTO VALUES REQUIRED NORMVORGABE VALEUR PRESCRITE VALOR PRESCRITO ЗАДАННОЕ ЗНАЧЕНИЕ EN 14411 ISO 13006 - BIII (GL)	VALORE MEDIO FAP* AVERAGE FAP RATING DURCHSCHNITTSWERT FAP VALEUR MOYENNE FAP VALOR MEDIO FAP СРЕДНЕЕ ЗНАЧЕНИЕ FAP BIII (GL)
Lunghezza e larghezza Spessore Ortogonalità Rettilineità degli spigoli Planarità Aspetto della superficie % senza difetti nel lotto di prova	Lenght and width Thickness Wedging Straightness of the edges Flatness Quality of the surface Faultless % within the sample lot	Seitenlänge Stärke Rechtwinkligkeit Kantengeradheit Ebenfächigkeit Oberflächenqualität % an fehlerfreien Fliesen im Prüfbett	Dimensions des côtés Épaisseur Orthogonalité Equerrage des angles Planéité Qualité de la surface % sans défauts dans le lot d'essai	Largo y ancho Espesor Ortogonalidad Rectilinealidad de las aristas Planicidad Aspecto de la superficie % sin defectos en el lote de prueba	Длина и ширина Толщина Ортогональность Прямолинейность углов Плоскостность Вид поверхности % без брака в пробной партии	EN ISO 10545-2	± 0,5% ± 5% ± 0,6% ± 0,5% ± 0,5%	± 0,3% ± 5% ± 0,3% ± 0,3% ± 0,3%
Assorbimento d'acqua Valore medio %	Water absorption Average value %	Wasseraufnahme Durchschnittswert %	Absorption d'eau Valeur moyenne %	Absorción de agua Valor medio %	Водопоглощение Среднее значение %	EN ISO 10545-3	> 10%	Conforme - In accordance Erfüllt - Conforme Соответствует
Resistenza alla flessione Carico di rottura in N Carico di rottura in N/mm <sup>2</sup>	Bending strength Breaking force in N Breaking force in N/mm <sup>2</sup>	Biegefestigkeit Bruchlast in N Bruchlast in N/mm <sup>2</sup>	Résistance à la flexion Charge de rupture en N Charge de rupture en N/mm <sup>2</sup>	Resistencia a la flexión Carga de rotura en N Carga de rotura en N/mm <sup>2</sup>	Прочность при изгибе Разрушающая нагрузка в N Разрушающая нагрузка в N/mm <sup>2</sup>	EN ISO 10545-4	600 15	Conforme In accordance Erfüllt - Conforme Соответствует
Resistenza agli sbalzi termici	Thermal shock resistance	Temperaturwechselbeständigkeit	Résistance aux écarts de température	Resistencia a los choques térmicos	Стойкость к перепадам температуры	EN ISO 10545-9	Metodo di prova disponibile Test method available Verfügbare Prüfmethode Méthode d'essai disponible Método de prueba disponible Доступный метод испытания	Conforme In accordance Erfüllt Conforme Соответствует
Resistenza al cavillo	Crazing resistance	Haarriß-Beständigkeit	Résistance aux craquelures	Resistencia al cuarteado	Сопrotivляемость образованию кракелюров	EN ISO 10545-11	Richiesta - Requested Gefordert - Exigée Solicitud Требуемое значение	Conforme - In accordance Erfüllt - Conforme Соответствует
Resistenza ai prodotti chimici	Chemical resistance	Chemikalienfestigkeit	Résistance aux produits chimiques	Resistencia a los productos químicos	Сопrotivляемость воздействию химических веществ	EN ISO 10545-13	GB MIN	Conforme - In accordance Erfüllt - Conforme Соответствует
Resistenza alle macchie	Stain resistance	Bständigkeit gegen Fleckenbildung	Résistance aux taches	Resistencia a las manchas	Стойкость к загрязнению	EN ISO 10545-14	Classe - Class - Klasse Classe - Класс 3	Classe - Class - Klasse Classe - Класс 5

### Pavimenti in gres porcellanato

Porcelain floor tiles / Bodenfliesen Feinsteinzeug / Sols gres cerame / Pavimentos en gres porcelánico / Напольная плитка из керамогранита

CARATTERISTICHE TECNICHE	TECHNICAL SPECIFICATIONS	TECHNISCHE EIGENSCHAFTEN	CARACTERISTIQUES TECHNIQUES	CARACTERÍSTICAS TÉCNICAS	ТЕХНИЧЕСКИЕ ХАРАКТЕРИСТИКИ	NORME STANDARDS NORMEN NORMES NORMAS НОРМЫ	VALORE PRESCRITTO VALUES REQUIRED NORMVORGABE VALEUR PRESCRITE VALOR PRESCRITO ЗАДАННОЕ ЗНАЧЕНИЕ EN 14411 ISO 13006 BIa (UGL e GL)	VALORE MEDIO FAP* AVERAGE FAP RATING DURCHSCHNITTSWERT FAP VALEUR MOYENNE FAP VALOR MEDIO FAP СРЕДНЕЕ ЗНАЧЕНИЕ FAP BIa (GL)
Lunghezza e larghezza Spessore Ortogonalità Rettilineità degli spigoli Planarità Aspetto della superficie % senza difetti nel lotto di prova	Lenght and width Thickness Wedging Straightness of the edges Flatness Quality of the surface Faultless % within the sample lot	Seitenlänge Stärke Rechtwinkligkeit Kantengeradheit Ebenfächigkeit Oberflächenqualität % an fehlerfreien Fliesen im Prüfbett	Dimensions des côtés Épaisseur Orthogonalité Equerrage des angles Planéité Qualité de la surface % sans défauts dans le lot d'essai	Largo y ancho Espesor Ortogonalidad Rectilinealidad de las aristas Planicidad Aspecto de la superficie % sin defectos en el lote de prueba	Длина и ширина Толщина Ортогональность Прямолинейность углов Плоскостность Вид поверхности % без брака в пробной партии	EN ISO 10545-2	± 0,5% ± 5% ± 0,6% ± 0,5% ± 0,5%	± 0,3% ± 5% ± 0,3% ± 0,3% ± 0,3%
Assorbimento d'acqua Valore medio	Water absorption Average value	Wasseraufnahme Durchschnittswert	Absorption d'eau Valeur moyenne	Absorción de agua Valor medio	Водопоглощение Среднее значение %	EN ISO 10545-3	0,5%	Conforme - In accordance Erfüllt - Conforme Соответствует
Resistenza alla flessione Carico di rottura in N Carico di rottura in N/mm <sup>2</sup>	Bending strength Breaking force in N Breaking force in N/mm <sup>2</sup>	Biegefestigkeit Bruchlast in N Bruchlast in N/mm <sup>2</sup>	Résistance à la flexion Charge de rupture en N Charge de rupture en N/mm <sup>2</sup>	Resistencia a la flexión Carga de rotura en N Carga de rotura en N/mm <sup>2</sup>	Прочность при изгибе Разрушающая нагрузка в N Разрушающая нагрузка в N/mm <sup>2</sup>	EN ISO 10545-4	1300 35	Conforme - In accordance Erfüllt - Conforme Соответствует
Resistenza agli sbalzi termici	Thermal shock resistance	Temperaturwechselbeständigkeit	Résistance aux écarts de température	Resistencia a los choques térmicos	Стойкость к перепадам температуры	EN ISO 10545-9	Metodo di prova disponibile Test method available Verfügbare Prüfmethode Méthode d'essai disponible Método de prueba disponible Доступный метод испытания	Conforme - In accordance Erfüllt - Conforme Соответствует
Resistenza all'abrasione (PEI)	Resistance to abrasion (PEI)	Abriebsfestigkeit (PEI)	Résistance à l'abrasion (PEI)	Resistencia a la abrasion (PEI)	Сопrotivление истиранию (PEI)	EN ISO 10545-7 PEI	Riportare la classe Indicate the class Klassenangabe gefordert Indiquer la classe Indicar la classe Передать класс.	Conforme - In accordance Erfüllt - Conforme Соответствует
Resistenza al gelo	Frost resistance	Frostbeständigkeit	Résistance au gel	Resistencia al hielo	Морозостойчивость	EN ISO 10545-12	Richiesta - Requested Gefordert - Exigée - Solicitud Требуемое значение	Tweed, Marrone, Vulcano: II Travertino Dorato, Grigio Perla, Cashmere, Rosa: IV Carrara Bianco: V
Resistenza ai prodotti chimici	Chemical resistance	Chemikalienfestigkeit	Résistance aux produits chimiques	Resistencia a los productos químicos	Сопrotivляемость воздействию химических веществ	EN ISO 10545-13	GB - MIN	Conforme (1) - In accordance Erfüllt - Conforme Соответствует
Resistenza alle macchie	Stain resistance	Bständigkeit gegen Fleckenbildung	Résistance aux taches	Resistencia a las manchas	Стойкость к загрязнению	EN ISO 10545-14	Classe - Class Klasse - Klasse 3 - Класс 3	Classe - Class Klasse - Klasse 3 - Класс 5

## Misure, pesi ed imballi

Size, weight and packaging - Masse, Gewicht und Verpackung - Format, poids conditionnement - Medidas, pesos y embalajes - Размеры, вес и упаковка.

### Rivestimenti 30,5x91,5 Rettificati e Pavimenti coordinati.

Wall tiles in size 30,5x91,5 (12"x36") and matching floor tiles. / Wandfliesen im Format 30,5x91,5 und dazu passende Bodenfliesen. / Revêtements muraux en 30,5x91,5 et sols coordonnés. / Revestimientos 30,5x91,5 y pavimentos coordinados. Ректифицированная настенная плитка 30,5x91,5 и напольная плитка в комплекте.

	FORMATO IN CM E POLLICI SIZE IN CM AND INCHES FORMAT IN CM UND ZOLL FORMAT EN CM ET POUÇES FORMATO EN CM Y PULGADAS ФОРМАТ В CM И ДЮЙМАХ	SPESSORE IN MM THICKNESS MM STÄRKE MM ÉPAISSEUR EN MM ESPESOR EN MM ТОЛЩИНА В MM	PZ/SCATOLA PIECES/BOX STÜCK/KARTON PIÈCES/BOÎTE PIEZAS/CAJA ШТ. В КОРОБКЕ	MQ/SCATOLA MQ/BOX MQ/KARTON MQ/BOÎTE MQ/CAJA КВ.М В КОРОБКЕ	ML/SCATOLA ML/BOX ML/KARTON ML/BOÎTE ML/CAJA ПОГОНЬМЕТРОВ В КОРОБКЕ	KG/SCATOLA KG/BOX KG/KARTON KG/BOÎTE KG/CAJA КГ В КОРОБКЕ	SCATOLA/PALLET BOX/PALLET KARTON/PALLET BOÎTE/PALLET CAJA/PALET КОРОБОК В ПОДДОНЕ
Rivestimento	30,5X91,5 RT 12"x36"	11,5	4	1,116	-	24,40	40
Pavimento coordinato	30,5X30,5 RT 12"x12"	8,6	12	1,12	-	21,25	48
Mosaico	30,5x30,5 12"x12"	-	6	0,55	-	10,44	42
Alzata	30,5X17,5 RT 12"x17"	-	5	-	-	6,10	-
Angolo esterno alzata	2,5X17,5 RT 1"x17"	-	4	-	-	0,80	-
Capitello	30,5X12 RT 12"x4,8"	-	5	-	-	4,00	-
Angolo esterno capitello	2,5X12 RT 1"x4,8"	-	4	-	-	0,12	-
London	4X30,5 RT 1,6"x12"	-	10	-	-	2,10	-
Angolo esterno london	2,5X4 1"x1,6"	-	4	-	-	0,06	-
Spigolo	1,5X30,5 RT 0,6"x12"	-	10	-	-	3,00	-
Angolo esterno spigolo	1,5X1,5 0,6"x0,6"	-	4	-	-	0,05	-
Raccordo	2,5X30,5 RT 0,8"x12"	-	10	-	-	1,65	-
Drops listello	5,5x30,5 RT 2,2"x12"	-	10	-	-	3,67	-
Ode Inserto	30,5X91,5 RT 12"x36"	-	2	-	-	12,20	-
Ode listello	9,5X30,5 RT 3,8"x12"	-	5	-	-	2,50	-
Ode inserto pavimento	30,5X30,5 RT 12"x12"	-	4	-	-	14,00	-
Oggi inserto	30,5X91,5 RT 12"x36"	-	2	-	-	12,20	-
Oggi listello	7x30,5 RT 2,8"x12"	-	5	-	-	2,50	-
Oltre inserto mix 2	30,5x183 RT 12"x72"	-	1 mix	-	-	12,20	-
Oltre listello	4x91,5 RT 1,6"x36"	-	5	-	-	2,75	-
Opera inserto mix 3	91,5x91,5 RT 36"x36"	-	1 mix	-	-	18,30	-
Orme inserto	30,5X91,5 RT 12"x36"	-	2	-	-	12,20	-
Luce listello	5x30,5 RT 2"x12"	-	10	-	-	3,67	-
Roma listello	5,5x30,5 RT 2,2"x12"	-	5	-	-	1,80	-
Stream inserto	30,5X91,5 RT 12"x36"	-	2	-	-	12,20	-
Stream listello	2,5x91,5 RT 1"x36"	-	5	-	-	2,75	-
Stream listello	2,5x30,5 RT 0,8"x12"	-	5	-	-	1,35	-

- Valore medio dei test condotti negli ultimi 24 mesi.  
Average rating of tests conducted during the last 24 months.  
Durchschnittswert der in den letzten 24 Monaten durchgeführten Tests.  
Valeur moyenne des essais menés au cours des 24 derniers mois.  
Valor medio de las pruebas llevadas a cabo en los últimos 24 meses.  
Среднее значение испытаний, проведенных в течение последних 24 месяцев.



## TonosuTono stuccature coordinate Fap.

Fap co-ordinated grout joints. / Koordinierte Fugenmassen Fap. / Joints coordonnés Fap. / Material de relleno coordinado Fap. / координированное оштукатуривание Fap.

### Abbinamento piastrelle/stucco.

Tile / grout combinations. / Zusammenstellung Fliesen/Fugenmasse. / Carreaux / mortier assorti. / Combinación azulejos / material de relleno. / Сочетание плитка / штукатурка.

STUCCO ABBINATO.  
COMBINED GROUT. / DAZUPASSENDE FUGENMASSE.  
MORTIER ASSORTI. / MATERIAL DE REJUNTADO. / СОЧЕТАЕМОЙ ШТУКАТУРКИ.

BIANCO BRILLANTE 30,5X91,5 RT	TONOSUTONO 01 BIANCO
NERO ASSOLUTO 30,5X91,5 RT	TONOSUTONO 12 NERO
ORIENTE BEIGE 30,5X91,5 RT	TONOSUTONO 02 GESSO
ORIENTE GRIGIO 30,5X91,5 RT	TONOSUTONO 01 BIANCO
ORIENTE TERRA 30,5X91,5 RT	TONOSUTONO 16 TABACCO
ROSA INCANTO 30,5X91,5 RT	TONOSUTONO 15 MAGNOLIA
DORATO CLASSICO 30,5X91,5 RT	TONOSUTONO 02 GESSO
GRIGIO CLASSICO 30,5X91,5 RT	TONOSUTONO 01 BIANCO
MARRONE PROFONDO 30,5X91,5 RT	TONOSUTONO 14 MARRONE
VULCANO 30,5X91,5 RT	TONOSUTONO 12 NERO
PASSION CARRARA BIANCO 30,5X30,5 RT	TONOSUTONO 01 BIANCO
RENOVA TRAVERTINO DORATO 30,5X30,5 RT	TONOSUTONO 02 GESSO
RENOVA GRIGIO PERLA 30,5X30,5 RT	TONOSUTONO 01 BIANCO
EVOLUTA CASHMERE 30,5X30,5 RT	TONOSUTONO 02 GESSO
EVOLUTA TWEED 30,5X30,5 RT	TONOSUTONO 16 TABACCO
MARRONE PROFONDO 30,5X30,5 RT	TONOSUTONO 14 MARRONE
ROSA INCANTO 30,5X30,5 RT	TONOSUTONO 15 MAGNOLIA
VULCANO 30,5X30,5 RT	TONOSUTONO 12 NERO
BEIGE MOSAICO 30,5X30,5	TONOSUTONO 02 GESSO
BIANCO MOSAICO 30,5X30,5	TONOSUTONO 01 BIANCO
GRIGIO MOSAICO 30,5X30,5	TONOSUTONO 01 BIANCO
MARRONE MOSAICO 30,5X30,5	TONOSUTONO 14 MARRONE
NERO MOSAICO 30,5X30,5	TONOSUTONO 12 NERO
ROSA MOSAICO 30,5X30,5	TONOSUTONO 15 MAGNOLIA
BEIGE ROMBI MOSAICO 30,5X30,5	TONOSUTONO 02 GESSO
NERO ROMBI MOSAICO 30,5X30,5	TONOSUTONO 12 NERO
GESSATO ORO MOSAICO 30,5X30,5	TONOSUTONO 14 MARRONE
STREAM MOSAICO 30,5X30,5	TONOSUTONO 12 NERO
ORO MOSAICO 30,5X30,5	TONOSUTONO 02 GESSO
DROPS MARRONE LISTELLO 5,5X30,5 RT	TONOSUTONO 14 MARRONE
DROPS ROSA LISTELLO 5,5X30,5 RT	TONOSUTONO 02 GESSO
ODE BIANCO NERO INSERTO 30,5X91,5 RT	TONOSUTONO 01 BIANCO
ODE BEIGE INSERTO 30,5X91,5 RT	TONOSUTONO 02 GESSO
ODE ROSA INSERTO 30,5X91,5 RT	TONOSUTONO 15 MAGNOLIA
ODE BIANCO NERO LISTELLO 9,5X30,5 RT	TONOSUTONO 01 BIANCO
ODE BEIGE LISTELLO 9,5X30,5 RT	TONOSUTONO 02 GESSO
ODE ROSA LISTELLO 9,5X30,5 RT	TONOSUTONO 15 MAGNOLIA
ODE BIANCO NERO INSERTO PAV 30,5X30,5 RT	TONOSUTONO 01 BIANCO
OGGI BEIGE MARRONE INSERTO 30,5X91,5 RT	TONOSUTONO 02 GESSO
OGGI BIANCO NERO INSERTO 30,5X91,5 RT	TONOSUTONO 01 BIANCO
OGGI BEIGE MARRONE LISTELLO 7X30,5 RT	TONOSUTONO 02 GESSO
OGGI BIANCO NERO LISTELLO 7X30,5 RT	TONOSUTONO 01 BIANCO
OLTRE A INSERTO MIX 230,5X183 RT	TONOSUTONO 01 BIANCO
OLTRE B INSERTO MIX 230,5X183 RT	TONOSUTONO 01 BIANCO
OLTRE C INSERTO MIX 230,5X183 RT	TONOSUTONO 01 BIANCO
OLTRE LISTELLO 4x91,5 RT	TONOSUTONO 01 BIANCO
OPERA MARRONE INSERTO MIX 391,5X91,5 RT	TONOSUTONO 16 TABACCO
OPERA ROSA INSERTO MIX 391,5X91,5 RT	TONOSUTONO 15 MAGNOLIA
ORMA GRIGIO INSERTO 30,5X91,5 RT	TONOSUTONO 01 BIANCO
ORMA MARRONE INSERTO 30,5X91,5 RT	TONOSUTONO 16 TABACCO
LUCE BEIGE LISTELLO 5X30,5 RT	TONOSUTONO 02 GESSO
LUCE PESCA LISTELLO 5X30,5 RT	TONOSUTONO 02 GESSO
ROMA BIANCO LISTELLO 5,5X30,5 RT	TONOSUTONO 01 BIANCO
ROMA DUNA LISTELLO 5,5X30,5 RT	TONOSUTONO 02 GESSO
ROMA NERO LISTELLO 5,5X30,5 RT	TONOSUTONO 12 NERO
STREAM ORO INSERTO 30,5X91,5 RT	TONOSUTONO 02 GESSO
STREAM ORO LISTELLO 2,5X91,5 RT	TONOSUTONO 02 GESSO
STREAM ORO LISTELLO 2,5X30,5 RT	TONOSUTONO 02 GESSO
STREAM ARGENTO INSERTO 30,5X91,5 RT	TONOSUTONO 12 NERO
STREAM ARGENTO LISTELLO 2,5X91,5 RT	TONOSUTONO 12 NERO

## Pesi e imballi.

Weights and packaging. / Gewicht und Verpackungen. / Poids et emballages. / Peso y embalaje. / Вес и упаковка.

	FORMATO IN CM E POLLICI SIZE IN CM AND INCHES FORMAT IN CM UND ZOLL FORMAT EN CM ET POUÇES FORMATO EN CM Y PULGADAS ФОРМАТ В CM И ДЮЙМАХ	SPESSORE IN MM THICKNESS MM STÄRKE MM ÉPAISSEUR EN MM ESPESOR EN MM ТОЛЩИНА В MM	PZ/SCATOLA PIECES/BOX STÜCK/KARTON PIÈCES/BÔITE PIEZAS/CAJA ШТ. В КОРОБКЕ	MQ/SCATOLA MQ/BOX MQ/KARTON MQ/BÔITE MQ/CAJA КВ.М В КОРОБКЕ	ML/SCATOLA ML/BOX ML/KARTON ML/BÔITE ML/CAJA ПОТОНЬК МЕТРОВ В КОРОБКЕ	KG/SCATOLA KG/BOX KG/KARTON KG/BÔITE KG/CAJA КГ В КОРОБКЕ	SCATOLA/PALLET BOX/PALLET KARTON/PALLET BÔITE/PALLET CAJA/PALET КОРОБОК В ПОДДОНЕ
Tonosutono	-	-	-	-	-	5,00	96

## Tabella consumi.

Usage table. / Tableau de consommation. / Verbrauchstabelle. / Tabla de consumos. / Таблица потребления

FORMATO PIASTRELLA IN CMXCM TILE SIZE IN CMXCM / FORMAT CARREAU EN CMXCM / FLIESENFORMAT IN CMXCM FORMATO AZULEJO EN CMXCM / РАЗМЕР ПЛИТКИ CM X CM	LARGHEZZA FUGA (MM) WIDTH OF GAP (MM) / LARGEUR JOINT (MM) / FUGENBREITE (MM) ANCHURA JUNTA (MM) / ШИРИНА ШВА (MM)	KG/MQ KG/M2 / KG/M2 KG/M2 / KG/M2 / КГ/КВ.М
Mosaico 2x2 / 2x2 mosaic / Mosaïque 2x2 / Mosaico 2x2 / Мозаика 2x2	0-2	1,20
20x20	0-2	0,30
15x56	0-2	0,25
25x45	0-2	0,22
30,5x30,5	0-2	0,24
30,5x56	0-2	0,20
30,5x91,5	0-2	0,17
45x45	0-2 0-3	0,18
60x60	0-2 0-3	0,15

Gli abbinamenti fra colore della piastrella e colore dello stucco sono studiati per realizzare bagni identici a quelli rappresentati nelle immagini del catalogo. Per ottenere il miglior risultato estetico non sempre il colore della piastrella coincide con il colore dello stucco che Fap ceramiche consiglia. Sugeriamo di stuccare gli inserti con lo stesso stucco utilizzato per il resto del bagno.

The combinations between the colour of the tile and the colour of the grout have been studied to create bathrooms identical to those portrayed in the catalogue's pictures. For the best visual result the colour of the tile should not always coincide with the colour of grout that Fap Ceramiche recommends. We suggest that you grout the inserts with the same grout used for the rest of the bathroom.

Die Kombinationen zwischen der Farbe der Fliesen und der Farbe der Fugenmasse wurden dafür studiert, Badezimmer zu gestalten, die haargenau den in den Bildern des Katalogs dargestellten entsprechen. Um das beste ästhetische Ergebnis zu erzielen, muss die Farbe der Fliesen nicht immer unbedingt mit der von Fap Ceramiche empfohlenen Fugenmassenfarbe übereinstimmen. Wir empfehlen, die Einsätze mit der für das restliche Badezimmer verwendeten Fugenmasse zu verfugen.

Les assortiments entre la couleur du carreau et la couleur du mortier sont étudiés pour réaliser des salles de bains identiques à celles représentées sur les images du catalogue. Afin d'obtenir le meilleur résultat esthétique, étant donné que la couleur du carreau ne coïncide pas toujours avec celle du mortier que Fap Ceramiche recommande, nous conseillons de mastiquer les insertions avec le même mortier utilisé pour le reste de la salle de bains.

Las combinaciones entre el color del azulejo y el color del material de rejuntado han sido estudiadas para realizar baños idénticos a los representados en las imágenes del catálogo. A fin de obtener el mejor resultado estético, el color del azulejo no siempre coincide con el color del material de rejuntado aconsejado por Fap Ceramiche. Aconsejamos rellenar las juntas de los insertos con el mismo material de rejuntado utilizado para el resto del baño.

Сочетания цвета плитки с цветом штукатурки были изучены, чтобы создать ванны комнаты, идентичные тем, что представлены в изображениях каталога. Для получения наилучшего эстетического результата не всегда цвет плитки совпадает с цветом штукатурки, которую рекомендует компания Fap ceramiche.

Советуем оштукатуривать вставки той же штукатуркой, которая применялась для ванной.

I colori e le caratteristiche estetiche dei materiali illustrati nel presente catalogo sono da ritenersi puramente indicativi.

Colours and optical features of the materials illustrated in this catalogue are to be regarded as mere indications.

Die Farben und die ästhetischen Eigenschaften der in diesem Katalog abgebildeten Produkte sind als reine Richtwerte zu betrachten.

Les coloris et les caractéristiques esthétiques des références illustrées dans le catalogue sont donnés à titre purement indicatif.

Los colores y las características ópticas de los materiales ilustrados en este catalogo deben ser mirados como indicaciones meras.

Цвета и эстетические характеристики описанных в настоящем каталоге материалов являются только ориентировочными.

Fap ceramiche si riserva di apportare modifiche senza preavviso ai prodotti declinando ogni responsabilità per danni diretti o indiretti derivanti da eventuali modifiche.

Fap ceramiche can change the indicated products without notice declining any responsibility for direct or indirect damage that depend on these changes.

Fap ceramiche kann die genannten Produkten ändern ohne Voranmeldung und lehnt dabei jegliche Verantwortung für die davon abhängenden direkten oder indirekten Schäden ab.

Fap ceramiche se réserve le droit de modifier sans préavis les produits indiqués et décline toute responsabilité pour dommages directs ou indirects dus à éventuelles modifications.

Fap ceramiche se reserva la facultad de modificar los productos sin preaviso, declinando cualquier responsabilidad por daños directos o indirectos que dependan de estos cambios.

Компания "Fap ceramiche" сохраняет за собой право на внесение изменений в продукцию без предварительного уведомления, снимая с себя всякую ответственность за связанный с этими изменениями прямой или не прямой ущерб.

