

A stylized, grayscale city skyline graphic composed of various rectangular blocks of different heights and widths, creating a jagged horizon line. The graphic is positioned at the top of the page, with the word 'building' overlaid on it.

# building

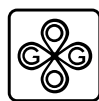

**GARDENIA  
ORCHIDEA**

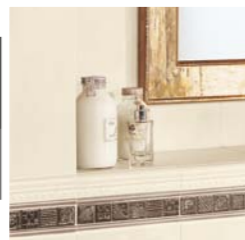

# building

<b>COLLEZIONI</b> COLLECTIONS	<b>RIVESTIMENTI</b> WALL TILES	<b>PAVIMENTI</b> FLOOR TILES	<b>PAGINA</b> PAGE
<b>bistrò</b>	20x20	-	14
<b>cemento</b>	-	34x34	32
<b>filosofi</b>	25x41	-	8
	-	33,3x33,3	38
	-	41x41	28
<b>florence</b>	-	34x34	34
<b>karma</b>	-	41x41	30
<b>le crete di Pian della Fornace</b>	20x20	-	16
<b>luminor</b>	-	50x50	24
<b>minimal</b>	-	60,5x60,5	20
		30,5x60,5	22
<b>nirvana</b>	25x41	-	10
<b>perla</b>	-	50x50	26
<b>pulsar</b>	20x33,3	-	12
<b>shakespeare</b>	-	33,3x33,3	40
<b>textile</b>	-	41x41	27
<b>velvet</b>	20x50	-	4
	<b>informazioni</b> <b>information</b>		42

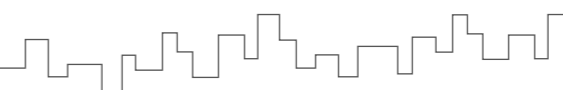

# consultazione catalogo

using the catalogue  
consultation du catalogue  
im katalog nachschlagen  
consulta de catálogo  
ИЗУЧЕНИЕ КАТАЛОГА  
目录查阅

## CARATTERISTICHE COLLEZIONE

COLLECTION CHARACTERISTICS  
CARACTÉRISTIQUES DE LA COLLECTION  
EIGENSCHAFTEN DER KOLLEKTION  
CARACTERÍSTICAS COLECCIÓN  
ХАРАКТЕРИСТИКИ КОЛЛЕКЦИИ  
系列特点

## CARATTERISTICHE TECNICHE

TECHNICAL CHARACTERISTICS  
CARACTÉRISTIQUES TECHNIQUES  
TECHNISCHE EIGENSCHAFTEN  
CARACTERÍSTICAS TÉCNICAS  
ТЕХНИЧЕСКИЕ ХАРАКЕРИСТИКИ  
技术特性

### filosofi 41x41 (16"x16")

PAVIMENTO | 41x41 | SPESSORE 10mm | 3 COLORI

011 - 1,512 m<sup>2</sup>/box



14045 SOCRATE (SABBIA)



14046 PLATONE (VERDE)



14047 DIOGENE (ROSA)

ROSONE (4 PEZZI PER COMPOSIZIONE) 41x41

021 - 4 pcs/box



10400 PLATONE/SENECA



10401 DIOGENE

FASCIA 25x41

025 - 4 pcs/box



10405 SOCRATE/PLATONE/SENECA



10410 DIOGENE



PLATONE

FONDI: CODICE PREZZO AL M<sup>2</sup> E M<sup>2</sup> PER SCATOLA  
FIELD: PRICE CODE PER M<sup>2</sup> AND M<sup>2</sup> PER BOX  
UNIS: CODE PRIX AU M<sup>2</sup> ET QUANTITÉ DE M<sup>2</sup> PAR BOÎTE  
UNIFLIESEN: PREISCODE PRO M<sup>2</sup> UND M<sup>2</sup> PRO SCHACHTEL  
FONDOS: CÓDIGO PRECIOS POR M<sup>2</sup> Y M<sup>2</sup> POR CAJA  
ФОН: КОД ЦЕНЫ ЗА М<sup>2</sup> И КОЛИЧЕСТВО М<sup>2</sup> В КОРОБКЕ  
主要墙地砖: 每平方米的欧元价格 和每箱的平方米数

FONDI: CODICE PRODOTTO  
BASE TILES: PRODUCT CODEE  
FONDOS: CODE DU PRODUIT  
GRUNDFLIESEN: PRODUKTNUMMER  
FONDOS: CÓDIGO PRODUCTO  
ФОН: КОД ИЗДЕЛИЯ И ФОРМАТ  
主要墙地砖: 产品代号和规格

DECORI: CODICE PREZZO PER PEZZO E PEZZI PER SCATOLA  
DECORATIONS: PRICE CODE PER PÉCE AND PÉCES PER BOX  
DÉCORS: CODE PRIX PAR PÉCE ET QUANTITÉ DE PÉCES PAR BOÎTE  
DEKORELEMENTE: PREISCODE PRO STÜCK UND STÜCKE PRO SCHACHTEL  
DECORACIONES: CÓDIGO PRECIO POR UNIDAD Y UNIDADES POR CAJA  
ДЕКОРЫ: КОД ЦЕНЫ ЗА ШТУКУ И КОЛИЧЕСТВО ШТУК В КОРОБКЕ  
装饰砖: 每件的欧元价格 和每箱的件数

NORMA DI CONFORMITÀ  
COMPLIANCE STANDARD  
NORME DE CONFORMITÉ  
KONFORMITÄTSNORM  
NORMA DE CONFORMIDAD  
СТАНДАРТЫ СООТВЕТСТВИЯ  
符合标准

BATTISCOPA 8x33,3	GRADONE 33,3x35	ANGOLARE 35x35
02 - 30 pcs/box	31 - 4 pcs/box	39 - 2 pcs/box
18300 SOCRATE 18305 PLATONE 18310 DIOGENE	16100 SOCRATE 16101 PLATONE 16102 DIOGENE	16120 SOCRATE 16121 PLATONE 16122 DIOGENE

PEZZI SPECIALI PER TIPOLOGIA E FORMATO  
SPECIAL TRIMS BY TYPE AND SIZE  
PIÈCES SPÉCIALES PAR TYPOLOGIE ET PAR FORMAT  
FORMTEILE PRO TYPOLOGIE UND FORMAT  
PIEZAS ESPECIALES POR TIPO Y FORMATO  
СПЕЦИАЛЬНЫЕ ИЗДЕЛИЯ ПО ТИПУ И ФОРМАТУ  
按系列和规格划分的特殊件

### IMBALLI E PESI

PACKINGS AND WEIGHTS • EMBALLAGES ET POIDS • VERPACKUNGEN UND GEWICHTE • EMBALAJES Y PESOS

MONOCOTTURA EN 14411/J Blla GL

FORMATO SIZE	pcs/box pcs/box	pcs/box pcs/box	sqm/box sqm/box	kg/box kg/box	kg/box kg/box	kg/box kg/box	kg/box kg/box	kg/box kg/box
Pavimento 41x41	6	9	1,512	29,00	30,00	48	72,57	1.400,00
Fascia 25x41	-	4	1,64 ml.	-	7,64	-	-	-
Composizione "4" 41x41	-	4	-	-	12,72	-	-	-
Gradone piastrella 33,3x35	-	4	-	-	10,00	-	-	-
Angolare piastrella 35x35	-	2	-	-	5,00	-	-	-
Battiscopa 8x33,3	-	30	10,00 ml.	-	15,42	-	-	-

### TABELLA DI PRODOTTO

PRODUCT SHEET  
TABLEAU DU PRODUIT  
PRODUKTTABELLE  
TABLA PRODUCTO  
ТАБЛИЦА ИЗДЕЛИЯ  
产品表

Le forniture sono effettuate alle condizioni generali di vendita di ceramiche gardenia orchidea riportate sul catalogo generale 2010.

Supplies are carried out under the general conditions ceramiche gardenia orchidea terms of sale as written on the general catalogue 2010.

Les fournitures sont effectuées selon le condition general de vente ceramiche gardenia orchidea comme indique sur le catalogue general 2010.

Die lieferung werden nach den general verkaufskonditionen del ceramiche gardenia orchidea durchgefuehrt, wie sie auf dem general katalog aufgefuehrt sind 2010.

Los suministros son efectuados segun las condiciones generales de venta gardenia orchidea que estan indicadas en el catalogo general 2010.

Поставки осуществляются на условиях компании «Ceramiche Gardenia Orchidea», приведенных в общем каталоге 2010.

供货应按照总图册所载的 Ceramiche Gardenia Orchidea 总条件进行。2010.

RIVESTIMENTO | 20x50 | SPESSORE 9mm | 8 COLORI



■06 - 1,300 m<sup>2</sup>/box



60200 BIANCO



60207 ROSA



60202 BEIGE



60205 VERDE



60204 AMBRA



60203 MOKA



60208 NOCE



60201 ANTRACITE

DECORO DAMASCO 20x50



●39 - 4 pcs/box



60260 BIANCO



60261 BEIGE

LISTELLO DAMASCO 6,2x50



●18 - 10 pcs/box



60265 BIANCO



60266 BEIGE

DECORO 20x50



●17 - 4 pcs/box

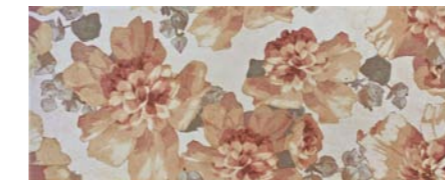

60225 CARTA DA PARATI







LISTELLO 6,2x50



●09 - 10 pcs/box



60226 CARTA DA PARATI

 MATITA 1x50	 GOCCIA MATITA 1x1	 TORELLO 4x50	 RACCORDO TORELLO 4x2	 COPRISPIGOLO 1x33,3	 RACCORDO COPRISPIGOLO 1x1	 PROFILO METALLO 0,5x50
●12 - 10 pcs/box	●12 - 10 pcs/box	●17 - 10 pcs/box	●17 - 10 pcs/box	●17 - 36 pcs/box	●14 - 10 pcs/box	●14 - 6 pcs/box
2640 BIANCO 2641 ANTRACITE 2642 BEIGE 2643 MOKA 2644 AMBRA 2645 VERDE 2647 ROSA 2648 NOCE	2690 BIANCO 2691 ANTRACITE 2692 BEIGE 2693 MOKA 2694 AMBRA 2695 VERDE 2697 ROSA 2698 NOCE	2850 BIANCO 2851 ANTRACITE 2852 BEIGE 2853 MOKA 2854 AMBRA 2855 VERDE 2857 ROSA 2858 NOCE	2870 BIANCO 2871 ANTRACITE 2872 BEIGE 2873 MOKA 2874 AMBRA 2875 VERDE 2877 ROSA 2878 NOCE	12710 BIANCO 12711 ANTRACITE 12712 BEIGE 12713 MOKA 12714 AMBRA 12715 VERDE 12717 ROSA 12718 NOCE	12720 BIANCO 12721 ANTRACITE 12722 BEIGE 12723 MOKA 12724 AMBRA 12725 VERDE 12727 ROSA 12728 NOCE	61045 ARGENTO 61046 BRONZO

# velvet 41x41 (16"x16")

## GRES PORCELLANATO SMALTATO

• GLAZED PORCELAIN TILES  
• GRÉS CÉRAME ÉMAILLÉ  
• GLASIERTES FEINSTEINZEUG  
• GRES PORCELÁNICO ESMALTADO  
• ГЛАЗУРОВАННЫЙ КЕРАМОГРАНИТ  
• 玻化上釉磚

PAVIMENTI COORDINATI | 41x41 | SPESSORE 9mm | 4 COLORI

1,010 m<sup>2</sup>/box



14170 BIANCO NAT 04  
14180 BIANCO LAP 11



14171 ANTRACITE NAT 04  
14181 ANTRACITE LAP 11



14172 BEIGE NAT 04  
14182 BEIGE LAP 11



14173 MOKA NAT 04  
14183 MOKA LAP 11

MOSAICO 64 MODULI | 41x41



34 - 4 PCS/BOX



14192 BEIGE

- 14190 BIANCO
- 14191 ANTRACITE
- 14193 MOKA



BATTISCOPA MOLATO 8x41

06 - 10 pcs/box

ML14170 BIANCO  
ML14171 ANTRACITE  
ML14172 BEIGE  
ML14173 MOKA



BEIGE/NOCE

### IMBALLI E PESI

PACKINGS AND WEIGHTS • EMBALLAGES ET POIDS • VERPACKUNGEN UND GEWICHTE • EMBALAJES Y PESOS

EN 14411/L BIII GL

FORMATO SIZE	pz/mq-pcs/m <sup>2</sup> pcs/sqm-stk/qm	pz/scat.-pcs/bte pcs/box-stk/krt	mq/scat-m <sup>2</sup> /bte sqm/box-qm/krt	kg/mq-kg/m <sup>2</sup> kg/sqm-kg/qm	kg/scat-kg/bte kg/box-kg/krt	scat/pal-bte/pal box/pal-krt/pal	mq/pal-m <sup>2</sup> /pal sqm/pal-qm/pal	kg/pal
Fondo 20x50	10	13	1,300	15,30	20,00	48	62,40	960,00
Decoro 20x50	-	4	-	-	5,90	-	-	-
Listello 6,2x50	-	10	5,00 ml.	-	5,00	-	-	-
Torello 4x50	-	10	5,00 ml.	-	4,00	-	-	-
Matita 1x50	-	10	5,00 ml.	-	1,60	-	-	-
Coprispigolo 1x33,3	-	36	12,00 ml.	-	1,32	-	-	-
Raccordo Torello 4x2	-	10	-	-	0,18	-	-	-
Goccia Matita 1x1	-	10	-	-	0,18	-	-	-
Raccordo Coprispigolo 1x1	-	10	-	-	0,18	-	-	-
Profili Metallo 0,5x50	-	6	3,00 ml.	-	0,42	-	-	-

EN 14411/G GL Bla

FORMATO SIZE	pz/mq-pcs/m <sup>2</sup> pcs/sqm-stk/qm	pz/scat.-pcs/bte pcs/box-stk/krt	mq/scat-m <sup>2</sup> /bte sqm/box-qm/krt	kg/mq-kg/m <sup>2</sup> kg/sqm-kg/qm	kg/scat-kg/bte kg/box-kg/krt	scat/pal-bte/pal box/pal-krt/pal	mq/pal-m <sup>2</sup> /pal sqm/pal-qm/pal	kg/pal
Pavimento 41x41	6	6	1,010	20,26	20,26	72	72,72	1.458,72
Mosaico 41x41	-	4	0,672	-	12,80	-	-	-
Battiscopa 8x41	-	10	4,10 ml.	-	5,55	-	-	-

RIVESTIMENTO | 25x41 | SPESSORE 8 mm | 3 COLORI



■ 02 | - 1,537 m<sup>2</sup>/box



5600 SOCRATE (SABBIA)



5605 PLATONE (VERDE)



5615 DIOGENE (ROSA)

LISTELLO 6,5x41



● 18 | - 9 pcs/box



1566 SOCRATE

PAVIMENTO | 33,3x33,3 | SPESSORE 9,5mm | 4 COLORI



■ 01 | - 1,774 m<sup>2</sup>/box



19590 SOCRATE (SABBIA)



19591 PLATONE (VERDE)



19592 DIOGENE (ROSA)



SOCRATE/DIOGENE



**TORELLO 5x41**

● 09 | - 12 pcs/box

770 SOCRATE  
773 PLATONE  
776 DIOGENE

IMBALLI E PESI

PACKINGS AND WEIGHTS • EMBALLAGES ET POIDS • VERPACKUNGEN UND GEWICHTE • EMBALAJES Y PESOS

EN 14411/L BIII GL

FORMATO SIZE	pz/mq-pcs/m <sup>2</sup> pcs/sqm-stk/qm	pz/scat.-pcs/bte pcs/box-stk/krt	mq/scat.-m <sup>2</sup> /bte sqm/box-qm/krt	kg/mq-kg/m <sup>2</sup> kg/sqm-kg/qm	kg/scat-kg/bte kg/box-kg/krt	scat/pal-bte/pal box/pal-krt/pal	mq/pal-m <sup>2</sup> /pal sqm/pal-qm/pal	kg/pal
Fondo 25x41	10	15	1,537	13,25	20,37	54	82,99	1.099,98
Torello 5x41	-	12	4,92 ml.	-	3,00	-	-	-
Listello 6,5x41	-	9	3,69 ml.	-	4,50	-	-	-
Pavimento 33,3x33,3	9	16	1,774	19,56	34,70	34	60,31	1179,97

# nirvana 25x41 (10"x16")

RIVESTIMENTO | 25x41 | SPESSORE 8 mm | 4 COLORI

■ 02 | - 1,537 m<sup>2</sup>/box



9155083 ROSA CHIARO



9155084 ROSA SCURO



9155076 AZZURRO CHIARO



9155077 AZZURRO SCURO

LISTELLO 4x25



● 08 | - 12 PCS/BOX



9155088 ROSA



9155081 AZZURRO

LISTELLO 7x25



● 09 | - 12 PCS/BOX



9155089 ROSA



9155082 AZZURRO

PAVIMENTO COORDINATO | 33,3x33,3 | SPESSORE 9 mm | 4 COLORI

■ 02 | - 1,332 m<sup>2</sup>/box



9155092 ROSA CHIARO



9155093 ROSA SCURO



9155090 AZZURRO CHIARO



9155091 AZZURRO SCURO



AZZURRO CHIARO/AZZURRO SCURO

MATITA 1,5x25	TORELLO 5x25	BATTISCOPA 10x25
● 03   - 36 PCS/BOX	● 07   - 15 PCS/BOX	● 11   - 12 PCS/BOX
9155087 ROSA 9155080 AZZURRO	9155086 ROSA 9155079 AZZURRO	9155085 ROSA 9155078 AZZURRO

## IMBALLI E PESI

PACKINGS AND WEIGHTS • EMBALLAGES ET POIDS • VERPACKUNGEN UND GEWICHTE • EMBALAJES Y PESOS

EN 14411/L BIII GL

FORMATO SIZE	pz/mq-pcs/m <sup>2</sup> pcs/sqm-stk/qm	pz/scat.-pcs/bte pcs/box-stk/krt	mq/scat.-m <sup>2</sup> /bte sqm/box-qm/krt	kg/mq-kg/m <sup>2</sup> kg/sqm-kg/qm	kg/scat-kg/bte kg/box-kg/krt	scat/pal-bte/pal box/pal-krt/pal	mq/pal-m <sup>2</sup> /pal sqm/pal-qm/pal	kg/pal
Rivestimento 25x41	10	15	1,537	13,25	20,37	54	82,99	1.099,98
Matita 1,5x25	-	36	9,00 ml.	-	2,99	-	-	-
Listello 4x25	-	12	3,00 ml.	-	2,20	-	-	-
Listello 7x25	-	12	3,00 ml.	-	2,00	-	-	-
Torello 5x25	-	15	3,75 ml.	-	2,49	-	-	-
Battiscopa 10x25	-	12	3,00 ml.	-	4,35	-	-	-
Pavimento 33,3x33,3	9	12	1,332	13,86	18,50	44	58,60	814,00

RIVESTIMENTO | 20x33,3 | SPESSORE 8mm | 2 COLORI



■02] - 1,132 m<sup>2</sup>/box

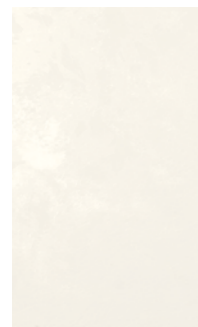

1230090 BIANCO



1230091 GRIGIO

LISTELLO 1x20



●05] - 36 pcs/box

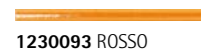

1230093 ROSSO



1230094 BLEU



1230095 VERDE



1230096 GIALLO

LISTELLO 2x33,3



●07] - 36 pcs/box



1230092 MULTICOLOR

PAVIMENTO | 33,3x33,3 | SPESSORE 8,5mm



■01] - 1,885 m<sup>2</sup>/box



1230097 GRIGIO

MOSAICO 36 MODULI 33,3x33,3



■29] - 4 pcs/box



1230098 GRIGIO



BIANCO/GRIGIO

IMBALLI E PESI

PACKINGS AND WEIGHTS • EMBALLAGES ET POIDS • VERPACKUNGEN UND GEWICHTE • EMBALAJES Y PESOS

EN 14411/L BIII GL

FORMATO SIZE	pz/mq-pcs/m <sup>2</sup> pcs/sqm-stk/qm	pz/scat.-pcs/bte pcs/box-stk/krt	mq/scat.-m <sup>2</sup> /bte sqm/box-qm/krt	kg/mq-kg/m <sup>2</sup> kg/sqm-kg/qm	kg/scat.-kg/bte kg/box-kg/krt	scat/pal-bte/pal box/pal-krt/pal	mq/pal-m <sup>2</sup> /pal sqm/pal-qm/pal	kg/pal
Rivestimento 20x33,3	16	17	1,132	13,25	16,00	68	76,98	1.088,00
Listello 1x20	-	36	7,20 ml.	-	1,32	-	-	-
Listello 2x33,3	-	36	11,98 ml.	-	1,32	-	-	-
Pavimento 33,3x33,3	9	17	1,885	0,997	33,50	34	64,09	1139,00
Mosaico 33,3x33,3	-	4	-	-	8,00	-	-	-



# bistró 20x20 (8"x8")

RIVESTIMENTO | 20x20 | SPESSORE 8,5 mm | 6 COLORI



■ 01 - 1,000 m<sup>2</sup>/BOX



4040 BEIGE



4070 ROSA



4080 GIALLO



4030 ALMOND

LISTELLO LINEAR 5x20



● 10 - 25 PCS/BOX



4032 BEIGE



4035 ROSA



4036 GIALLO



4031 ALMOND

LISTELLO ROMBI LINEAR 2,5x20



● 09 - 25 PCS/BOX



4042 BEIGE



4045 ROSA



4046 GIALLO



4041 ALMOND

SIGARO ROMBI 2x20



● 03 - 25 PCS/BOX



4152 BEIGE



4155 ROSA



4156 GIALLO



4151 ALMOND

LISTELLO FLOREALE GRANDE 5x20



● 10 - 25 PCS/BOX



4371 BEIGE



4374 ROSA



4375 GIALLO

INSERTO FLOREALE 20x20



● 10 - 18 PCS/BOX

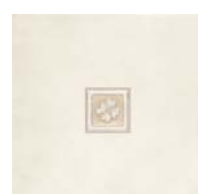

4391 BEIGE

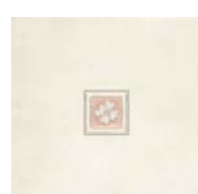

4394 ROSA

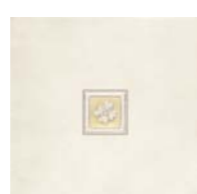

4395 GIALLO

	
TORELLO 3x20	MATITA 1x20
● 05 - 20 PCS/BOX	● 02 - 76 PCS/BOX
4051 ALMOND 4052 BEIGE 4055 ROSA 4056 GIALLO	4071 ALMOND 4072 BEIGE 4075 ROSA 4076 GIALLO



ALMOND/BEIGE

## IMBALLI E PESI

PACKINGS AND WEIGHTS • EMBALLAGES ET POIDS • VERPACKUNGEN UND GEWICHTE • EMBALAJES Y PESOS

BICOTTURA EN 14411/L BIII GL

FORMATO SIZE	pz/mq-pcs/m <sup>2</sup> pcs/sqm-stk/qm	pz/scat.-pcs/bte pcs/box-stk/krt	mq/scat.-m <sup>2</sup> /bte sqm/box-qm/krt	kg/mq-kg/m <sup>2</sup> kg/sqm-kg/qm	kg/scat.-kg/bte kg/box-kg/krt	scat/pal-bte/pal box/pal-krt/pal	mq/pal-m <sup>2</sup> /pal sqm/pal-qm/pal	kg/pal
Rivestimento 20x20	25	25	1,000	13,75	13,75	76	76,00	1.045,00
Inserto 20x20	-	18	-	-	10,44	-	-	-
Matita 1x20	-	76	15,20 ml.	-	2,79	-	-	-
Torello 3x20	-	20	4,00 ml.	-	2,26	-	-	-
Sigaro 2x20	-	25	5,00 ml.	-	1,75	-	-	-
Listello 2,5x20	-	25	5,00 ml.	-	4,00	-	-	-
Listello 5x20	-	25	5,00 ml.	-	4,00	-	-	-

# le crete di Pian della Fornace 20x20 (8"x8")



RIVESTIMENTO | 20x20 | SPESSORE 8 mm | 5 COLORI

■ 04 | - 1,000 m<sup>2</sup>/box



885 MONTALCINO (VERDE)



865 BOLGHIERI (ROSA)



880 GABELLINO (BEIGE)



875 TALAMONE (AZZURRO)



860 SATURNIA (BIANCO)

LISTELLO 13x20



● 15 | - 12 PCS/BOX



99 VERDE



95 ROSA



98 BEIGE



97 AZZURRO

TRIM 16x20



● 13 | - 18 PCS/BOX



2190 VERDE



2150 ROSA



2165 BEIGE



2160 AZZURRO



SATURNIA/BOLGHIERI

# le crete di Pian della Fornace 20x20 (8"x8")



## LISTELLO 5x20



## LISTELLO 10x20



## TRIANGOLO QUADRIFOGLIO 6,5x20



## SATURNIA FREGIO 20x20

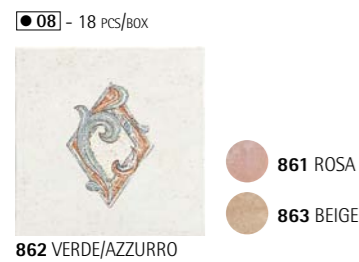

## INSERTO 20x20



	
<b>TORELLO 5x20</b>	<b>MATITA 1,5x20</b>
●06 - 20 PCS/BOX	●03 - 76 PCS/BOX
390 VERDE 350 ROSA 365 BEIGE 360 AZZURRO 370 BIANCO	58 VERDE 50 ROSA 56 BEIGE 54 AZZURRO



SATURNIA/MONTALCINO

### IMBALLI E PESI

PACKINGS AND WEIGHTS • EMBALLAGES ET POIDS • VERPACKUNGEN UND GEWICHTE • EMBALAJES Y PESOS

BICOTTURA EN 14411/L BIH GL

FORMATO SIZE	pz/mq-pcs/m² pcs/sqm-stk/qm	pz/scat-pcs/bte pcs/box-stk/krt	mq/scat-m²/bte sqm/box-qm/krt	kg/mq-kg/m² kg/sqm-kg/qm	kg/scat-kg/bte kg/box-kg/krt	scat/pal-bte/pal box/pal-krt/pal	mq/pal-m²/pal sqm/pal-qm/pal	kg/pal
Fondo 20x20	25	25	1,000	13,75	13,75	76	76,00	1.045,00
Inserto 20x20	-	18	-	-	10,44	-	-	-
Matita 1,5x20	-	76	15,20 ml.	-	2,79	-	-	-
Torello 5x20	-	20	4,00 ml.	-	3,20	-	-	-
Listello 5x20	-	25	5,00 ml.	-	4,00	-	-	-
Listello 10x20	-	18	3,60 ml.	-	4,35	-	-	-
Listello 13x20	-	12	2,40 ml.	-	4,20	-	-	-
Trim 16x20	-	18	3,60 ml.	-	8,00	-	-	-
Triangoli cucina 6,5x20	-	12	2,40 ml.	-	2,45	-	-	-

# minimal 60,5x60,5 (24"x24")



**GRES PORCELLANATO  
SMALTATO**

• GLAZED PORCELAIN TILES  
• GRÉS CÉRAMÉ EMAILÉ  
• GLASIERTES FEINSTEINZEUG  
• GRES PORCELÁNICO ESMALTADO  
• ГЛАЗУРОВАННЫЙ КЕРАМОГРАНИТ  
• 瓷化上釉砖

PAVIMENTO | 60,5x60,5 | SPESSORE 10,5mm | 4 COLORI



■ 11 - 1,098 m<sup>2</sup>/box



15880 BEIGE



15881 GRIGIO



15882 MARRONE

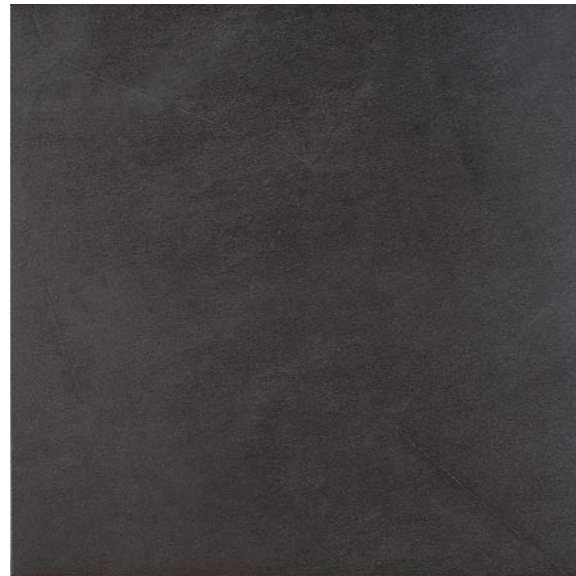

15883 NERO

FASCIA MOSAICO METALLO 2,5x60,5



● 23 - 6 PCS/BOX



15885 BEIGE-OTTONE



15886 GRIGIO-ACCIAIO



15887 MARRONE-OTTONE



15888 NERO-ACCIAIO



MARRONE

# minimal 30,5x60,5 (12"x24")

**GRES PORCELLANATO  
SMALTATO**

• GLAZED PORCELAIN TILES  
• GRÉS CÉRAME ÉMAILLÉ  
• GLASIERTES FEINSTEINZEUG  
• GRES PORCELÁNICO ESMALTADO  
• ГЛАЗУРОВАННЫЙ КЕРАМОГРАНИТ  
• 瓷化上釉砖

PAVIMENTO | 30,5x60,5 | SPESSORE 9,5mm | 4 COLORI



■ 08 | - 1,110 m<sup>2</sup>/box



15870 BEIGE



15871 GRIGIO



15872 MARRONE

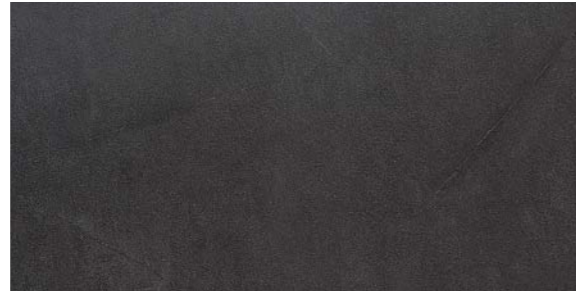

15873 NERO

MODULO MOSAICO INCISO 30,5x60,5



● 27 | - 4 pcs/box



15876 GRIGIO

- 15875 BEIGE
- 15877 MARRONE
- 15878 NERO

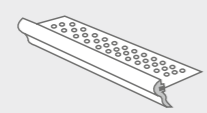
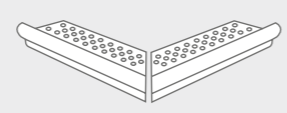

NERO/GRIGIO

		
BATTISCOPA 8x30,5	TORELLO GRADINO 5x30,5	TORELLO ANGOLARE 5x61
● 04   - 32 pcs/box	● 31   - 6 pcs/box	● 50   - 2 pcs/box
ML15870 BEIGE ML15871 GRIGIO ML15872 MARRONE ML15873 NERO	10970 BEIGE 10971 GRIGIO 10972 MARRONE 10973 NERO	10975 BEIGE 10976 GRIGIO 10977 MARRONE 10978 NERO

## IMBALLI E PESI

PACKINGS AND WEIGHTS • EMBALLAGES ET POIDS • VERPACKUNGEN UND GEWICHTE • EMBALAJES Y PESOS

EN 14411/G Bla GL

FORMATO SIZE	pz/mq-pcs/m <sup>2</sup> pcs/sqm-stk/qm	pz/scat-pcs/bte pcs/box-stk/krt	mq/scat-m <sup>2</sup> /bte sqm/box-qm/krt	kg/mq-kg/m <sup>2</sup> kg/sqm-kg/qm	kg/scat-kg/bte kg/box-kg/krt	scat/pal-bte/pal box/pal-krt/pal	mq/pal-m <sup>2</sup> /pal sqm/pal-qm/pal	kg/pal
Pavimento 30,5x60,5	5,50	6	1,110	20,00	22,20	48	53,28	1.065,60
Pavimento 60,5x60,5	2,80	3	1,098	23,67	26	40	43,92	1.040,00
Mosaico preinciso 30,5x60,5	-	4	0,738	-	14,80	-	-	-
Fascia 2,5x60,5	-	6	3,60 ml.	-	1,92	-	-	-
Battiscopa 8x30,5	-	32	9,76 ml.	-	16,00	-	-	-
Torello gradino 5x30,5	-	6	21,04 ml.	-	1,89	-	-	-
Torello angolare 5x61	-	2	-	-	1,20	-	-	-

# luminor 50x50 (20"x20")

**GRES PORCELLANATO  
SMALTATO**

• GLAZED PORCELAIN TILES  
• GRÉS CÉRAMÉ EMAILLÉ  
• GLASIERTES FEINSTEINZEUG  
• GRES PORCELÁNICO ESMALTADO  
• ГЛАЗУРОВАННЫЙ КЕРАМОГРАНИТ  
• 瓷化上釉砖

PAVIMENTO | 50x50 | SPESSORE 10mm | 5 COLORI



■ 13 - 1,000 m<sup>2</sup>/box



9117000 DIAMANTE BIANCO



9117003 PERLA NEUTRO AVORIO



9117004 ANDALUSITE BEIGE



9117005 QUARZO FUMÉ MOKA



9117002 NERO PERLA

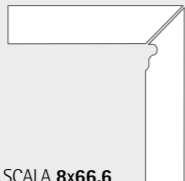
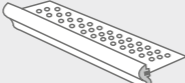
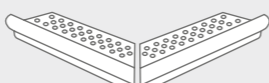

NERO PERLA

			
<b>BATTISCOPA 8x49</b>	<b>BATTISCOPA SCALA 8x66,6</b>	<b>TORELLO GRADONE 5x33,3</b>	<b>TORELLO ANGOLARE 5x66</b>
● 09 - 10 pcs/box	● 19 - 3 pcs/box	● 31 - 6 pcs/box	● 51 - 2 pcs/box
117240 BIANCO 117243 AVORIO 117244 BEIGE 117245 MOKA 117242 NERO	DX 117111 BIANCO DX 117126 AVORIO DX 117131 BEIGE DX 117136 MOKA DX 117121 NERO	SX 117112 BIANCO SX 117127 AVORIO SX 117132 BEIGE SX 117137 MOKA SX 117122 NERO	117160 BIANCO 117163 AVORIO 117164 BEIGE 117165 MOKA 117162 NERO

## IMBALLI E PESI

PACKINGS AND WEIGHTS • EMBALLAGES ET POIDS • VERPACKUNGEN UND GEWICHTE • EMBALAJES Y PESOS

EN 14411/G Bla GL

FORMATO SIZE	pz/mq-pcs/m <sup>2</sup> pcs/sqm-stk/qm	pz/scat-pcs/bte pcs/box-stk/krt	mq/scat-m <sup>2</sup> /bte sqm/box-qm/krt	kg/mq-kg/m <sup>2</sup> kg/sqm-kg/qm	kg/scat-kg/bte kg/box-kg/krt	scat/pal-bte/pal box/pal-krt/pal	mq/pal-m <sup>2</sup> /pal sqm/pal-qm/pal	kg/pal
Pavimento 50x50	4	4	1,000	21,00	21,00	33	33,00	693,00
Battiscopa 8x50	-	10	5,00 ml.	-	10,00	-	-	-
Battiscopa scala 8x66	-	3	-	-	2,11	-	-	-
Torello gradino 5x33,3	-	6	2,00 ml.	-	1,90	-	-	-
Torello angolare gradino 5x66	-	2	-	-	1,20	-	-	-

# perla 50x50 (20"x20")

## GRES PORCELLANATO SMALTATO

• GLAZED PORCELAIN TILES  
• GRÉS CÉRAME ÉMAILLÉ  
• GLASIERTES FEINSTEINZEUG  
• GRES PORCELÁNICO ESMALTADO  
• ГЛАЗУРОВАННЫЙ КЕРАМОГРАНИТ  
• 玻化上釉磚

PAVIMENTO | 50x50 | SPESSORE 10mm | 4 COLORI



■10 - 1,000 m<sup>2</sup>/BOX



817070 CREMA



817071 BIANCO



817072 MOKA



817073 ANTRACITE

<b>BATTISCOPA 8x33</b>	<b>BATTISCOPA SCALA 8x66,6</b>	<b>TORELLO GRADONE 5x33,3</b>	<b>TORELLO ANGOLARE 5x66</b>
●02 - 30 PCS/BOX	●18 - 3 PCS/BOX	●31 - 4 PCS/BOX	●51 - 2 PCS/BOX
19050 CREMA 19055 BIANCO 19075 MOKA 19080 ANTRACITE	DX 19051 CREMA DX 19056 BIANCO DX 19076 MOKA DX 19081 ANTRACITE	SX 19052 CREMA SX 19057 BIANCO SX 19077 MOKA SX 19082 ANTRACITE	11100 CREMA 11101 BIANCO 11105 MOKA 11106 ANTRACITE
			11150 CREMA 11151 BIANCO 11155 MOKA 11156 ANTRACITE

### IMBALLI E PESI

PACKINGS AND WEIGHTS • EMBALLAGES ET POIDS • VERPACKUNGEN UND GEWICHTE • EMBALAJES Y PESOS

EN 14411/G BIa GL

FORMATO SIZE	pz/mq-pcs/m <sup>2</sup> pcs/sqm-stk/qm	pz/scat-pcs/bte pcs/box-stk/krt	mq/scat-m <sup>2</sup> /bte sqm/box-qm/krt	kg/mq-kg/m <sup>2</sup> kg/sqm-kg/qm	kg/scat-kg/bte kg/box-kg/krt	scat/pal-bte/pal box/pal-krt/pal	mq/pal-m <sup>2</sup> /pal sqm/pal-qm/pal	kg/pal
Pavimento 50x50	4	4	1,000	21,50	21,50	33	33,00	709,50
Battiscopa 8x33,3	-	30	10,00 ml.	-	10,55	-	-	-
Battiscopa scala 8x66	-	6	-	-	2,11	-	-	-
Torello gradino 5x33,3	-	6	2,00 ml.	-	1,89	-	-	-
Torello angolare 5x66	-	2	-	-	1,20	-	-	-

# textile 41x41 (16"x16")

## GRES PORCELLANATO SMALTATO

• GLAZED PORCELAIN TILES  
• GRÉS CÉRAME ÉMAILLÉ  
• GLASIERTES FEINSTEINZEUG  
• GRES PORCELÁNICO ESMALTADO  
• ГЛАЗУРОВАННЫЙ КЕРАМОГРАНИТ  
• 玻化上釉磚

PAVIMENTO | 41x41 | SPESSORE 9mm | 2 COLORI



■09 - 1,010 m<sup>2</sup>/BOX



14110 MOKA



14111 ANTRACITE

<b>BATTISCOPA 8x41</b>
●06 - 30 PCS/BOX
ML14110 MOKA ML14111 ANTRACITE

### IMBALLI E PESI

PACKINGS AND WEIGHTS • EMBALLAGES ET POIDS • VERPACKUNGEN UND GEWICHTE • EMBALAJES Y PESOS

EN 14411/G BIa GL

FORMATO SIZE	pz/mq-pcs/m <sup>2</sup> pcs/sqm-stk/qm	pz/scat-pcs/bte pcs/box-stk/krt	mq/scat-m <sup>2</sup> /bte sqm/box-qm/krt	kg/mq-kg/m <sup>2</sup> kg/sqm-kg/qm	kg/scat-kg/bte kg/box-kg/krt	scat/pal-bte/pal box/pal-krt/pal	mq/pal-m <sup>2</sup> /pal sqm/pal-qm/pal	kg/pal
Pavimento 41x41	6	6	1,010	20,60	20,60	72	72,72	1.483,20
battiscopa 8x41	-	10	4,10 ml.	-	5,55	-	-	-

# filosofi 41x41 (16"x16")



PAVIMENTO | 41x41 | SPESSORE 9,5mm | 3 COLORI



01 - 1,512 M<sup>2</sup>/BOX



ISO 5

14045 SOCRATE (SABBIA)



ISO 5

14046 PLATONE (VERDE)



ISO 5

14047 DIOGENE (ROSA)

ROSONE (4 PEZZI PER COMPOSIZIONE) 41x41



22 - 4 PCS/BOX

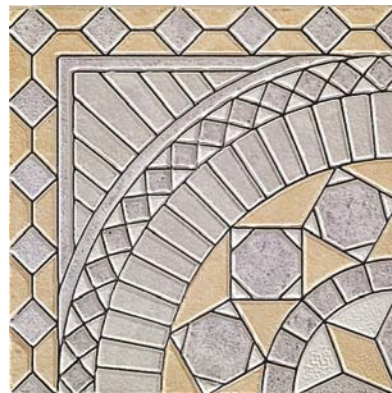

10400 PLATONE/SENECA

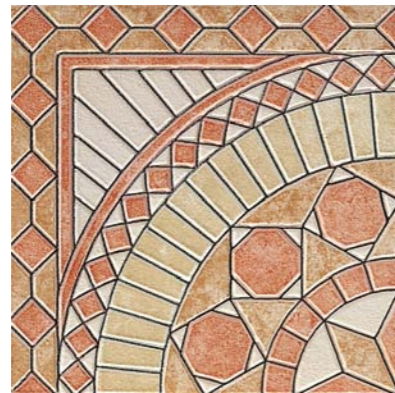

10401 DIOGENE

FASCIA 25x41



25 - 4 PCS/BOX



10405 SOCRATE/PLATONE/SENECA



10410 DIOGENE



PLATONE

BATTISCOPA 8x33,3	GRADONE 33,3x35	ANGOLARE 35x35
02 - 30 PCS/BOX	31 - 4 PCS/BOX	39 - 2 PCS/BOX
18300 SOCRATE 18305 PLATONE 18310 DIOGENE	16100 SOCRATE 16101 PLATONE 16102 DIOGENE	16120 SOCRATE 16121 PLATONE 16122 DIOGENE

## IMBALLI E PESI

PACKINGS AND WEIGHTS • EMBALLAGES ET POIDS • VERPACKUNGEN UND GEWICHTE • EMBALAJES Y PESOS

MONOCOTTURA EN 14411/J BIIa GL

FORMATO SIZE	pz/mq-pcs/m <sup>2</sup> pcs/sqm-stk/qm	pz/scat-pcs/bte pcs/box-stk/krt	mq/scat-m <sup>2</sup> /bte sqm/box-qm/krt	kg/mq-kg/m <sup>2</sup> kg/sqm-kg/qm	kg/scat-kg/bte kg/box-kg/krt	scat/pal-bte/pal box/pal-krt/pal	mq/pal-m <sup>2</sup> /pal sqm/pal-qm/pal	kg/pal
Pavimento 41x41	6	9	1,512	29,00	30,00	48	72,57	1.440,00
Fascia 25x41	-	4	1,64 ml.	-	7,64	-	-	-
Composizione "4" 41x41	-	4	-	-	12,72	-	-	-
Gradone piastrella 33,3x35	-	4	-	-	10,00	-	-	-
Angolare piastrella 35x35	-	2	-	-	5,00	-	-	-
Battiscopa 8x33,3	-	30	10,00 ml.	-	15,42	-	-	-



PAVIMENTO | 41x41 | SPESSORE 9mm | 4 COLORI



09 - 1,010 m<sup>2</sup>/BOX



14280 BEIGE



14282 MOKA



14281 GRIGIO

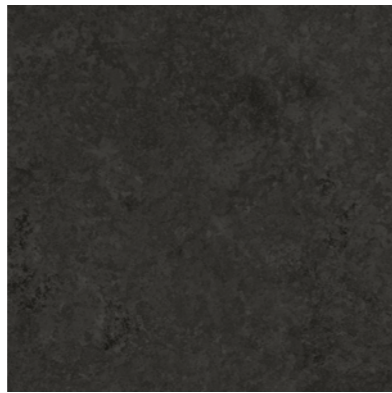

14283 NERO

MOSAICI 41x41



39 - 4 PCS/BOX

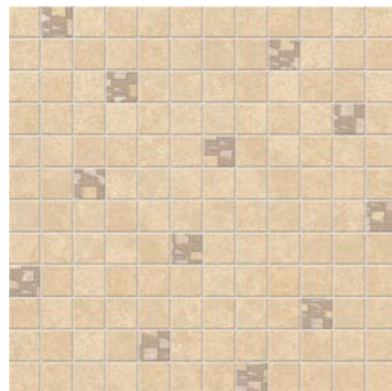

14340 BEIGE

- 14342 MOKA
- 14341 GRIGIO
- 14343 NERO

FASCIA 3,5x41



27 - 6 PCS/BOX



14460 BEIGE



14461 GRIGIO



14462 MOKA



14463 NERO



BEIGE



**BATTISCOPA 8x33,3**

06 - 30 PCS/BOX

ML14280 BEIGE  
ML14281 MOKA  
ML14282 GRIGIO  
ML14283 NERO

IMBALLI E PESI

PACKINGS AND WEIGHTS • EMBALLAGES ET POIDS • VERPACKUNGEN UND GEWICHTE • EMBALAJES Y PESOS

MONOCOTTURA EN 14411/GBIa

FORMATO SIZE	pz/mq-pcs/m <sup>2</sup> pcs/sqm-stk/qm	pz/scat.-pcs/bte pcs/box-stk/krt	mq/scat.-m <sup>2</sup> /bte sqm/box-qm/krt	kg/mq-kg/m <sup>2</sup> kg/sqm-kg/qm	kg/scat.-kg/bte kg/box-kg/krt	scat/pal-bte/pal box/pal-krt/pal	mq/pal-m <sup>2</sup> /pal sqm/pal-qm/pal	kg/pal
Pavimento 41x41 (versione B)	6	6	1,010	20,60	20,60	72	72,72	1.483,20
Pavimento 41x41 (versione O)	6	9	1,512	19,51	29,50	48	72,57	1.414,00
Mosaico 41x41	-	4	0,672	-	12,80	-	-	-
Fascia 3,5x41	-	6	2,46 ml.	-	1,80	-	-	-
Battiscopa 8x41	-	10	4,10 ml.	-	5,50	-	-	-

# cemento 34x34 (13<sup>1</sup>/<sub>4</sub>"x13<sup>1</sup>/<sub>4</sub>"

**GRES PORCELLANATO  
SMALTATO**

• GLAZED PORCELAIN TILES  
• GRÉS CÉRAMÉ EMAILLE  
• GLASIERTES FEINSTEINZEUG  
• GRES PORCELÁNICO ESMALTADO  
• ГЛАЗУРОВАННЫЙ КЕРАМОГРАНИТ  
• 玻化上釉砖

PAVIMENTO | 34x34 | SPESSORE 8,5mm | 4 COLORI



01 - 1,270 m<sup>2</sup>/box



15850 CREMA



15851 NATURA



15852 GRIGIO



15853 ANTRACITE

MOSAICO 36 MODULI 34x34



16 - 4 PCS/BOX

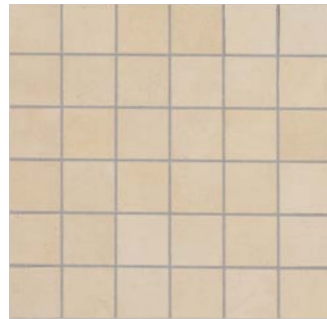

15860 CREMA

- 15861 NATURA
- 15862 GRIGIO
- 15863 ANTRACITE

MOSAICO 36 DECORATO METALLO 34x34



25 - 4 PCS/BOX

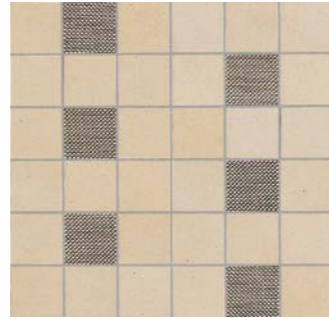

15865 CREMA

- 15866 NATURA
- 15867 GRIGIO
- 15868 ANTRACITE

FASCIA METALLO 3x34



12 - 24 PCS/BOX



15858 ACCIAIO



15859 OTTONE



NATURA

BATTISCOPA MOLATO 8x34	TORELLO GRADINO 5x34	TORELLO ANGOLARE 5x68
04 - 30 PCS/BOX	31 - 6 PCS/BOX	50 - 2 PCS/BOX
ML15850 CREMA ML15851 NATURA ML15852 GRIGIO ML15853 ANTRACITE	10960 CREMA 10961 NATURA 10962 GRIGIO 10963 ANTRACITE	10965 CREMA 10966 NATURA 10967 GRIGIO 10968 ANTRACITE

## IMBALLI E PESI

PACKINGS AND WEIGHTS • EMBALLAGES ET POIDS • VERPACKUNGEN UND GEWICHTE • EMBALAJES Y PESOS

EN 14411/G BlA GL

FORMATO SIZE	pz/mq-pcs/m <sup>2</sup> pcs/sqm-stk/qm	pz/scat-pcs/bte pcs/box-stk/krt	mq/scat-m <sup>2</sup> /bte sqm/box-qm/krt	kg/mq-kg/m <sup>2</sup> kg/sqm-kg/qm	kg/scat-kg/bte kg/box-kg/krt	scat/pal-bte/pal box/pal-krt/pal	mq/pal-m <sup>2</sup> /pal sqm/pal-qm/pal	kg/pal
Pavimento 34x34	9	11	1,270	17,32	22,00	48	60,96	1.056,00
Mosaico preinciso 34x34	-	4	0,462	-	7,27	-	-	-
Fascia 3x34	-	24	8,16 ml.	-	5,28	-	-	-
Battiscopa 8x34	-	30	10,20 ml.	-	13,68	-	-	-
Torello gradino 5x34	-	6	2,04 ml.	-	6,00	-	-	-
Torello angolare 5x68	-	2	-	-	2,00	-	-	-

# florence 34x34 (13 1/4" x 13 1/4")

**GRES PORCELLANATO  
SMALTATO**

• GLAZED PORCELAIN TILES  
• GRÉS CÉRAMÉ ÉMAILLÉ  
• GLASIERTES FEINSTEINZEUG  
• GRES PORCELÁNICO ESMALTADO  
• ГЛАЗУРОВАННЫЙ КЕРАМОГРАНИТ  
• 瓷化上釉砖

PAVIMENTO | 34x34 | SPESSORE 8,5mm | 4 COLORI



01 - 1,270 m<sup>2</sup>/box



15800 ROSSO



15805 TABACCO



15810 BEIGE



15815 ROSA

FASCIA 11x34



15 - 18 pcs/box

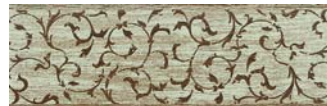

15820 VERDE



15821 TABACCO



15822 BEIGE



15823 ROSA

TOZZETTO 11x11



12 - 4 pcs/box



15825 VERDE



15826 TABACCO



15827 BEIGE



15828 ROSA

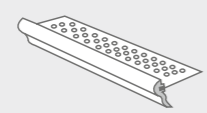
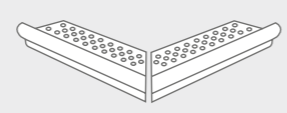

TABACCO

		
BATTISCOPA MOLATO 8x34	TORELLO GRADINO 5x34	TORELLO ANGOLARE 5x68
04 - 30 pcs/box	31 - 6 pcs/box	50 - 2 pcs/box
ML15800 ROSSO ML15805 TABACCO ML15810 BEIGE ML15815 ROSA	10940 ROSSO 10941 TABACCO 10942 BEIGE 10943 ROSA	10945 ROSSO 10946 TABACCO 10947 BEIGE 10948 ROSA

# florence 34x34 (13 1/4" x 13 1/4")

**GRES PORCELLANATO  
SMALTATO**

• GLAZED PORCELAIN TILES  
• GRÉS CÉRAME ÉMAILLÉ  
• GLASIERTES FEINSTEINZEUG  
• GRES PORCELÁNICO ESMALTADO  
• ГЛАЗУРОВАННЫЙ КЕРАМОГРАНИТ  
• 瓷化上釉砖

PAVIMENTO | 34x34 | SPESSORE 8,5mm | 4 COLORI



■ 01 - 1,270 m<sup>2</sup>/box



15801 MIX ROSSO



15806 MIX TABACCO



15811 MIX BEIGE



15816 MIX ROSA



ROSSO

## IMBALLI E PESI

PACKINGS AND WEIGHTS • EMBALLAGES ET POIDS • VERPACKUNGEN UND GEWICHTE • EMBALAJES Y PESOS

EN 14411/G Bla GL

FORMATO SIZE	pz/mq-pcs/m <sup>2</sup> pcs/sqm-stk/qm	pz/scat.-pcs/bte pcs/box-stk/krt	mq/scat.-m <sup>2</sup> /bte sqm/box-qm/krt	kg/mq-kg/m <sup>2</sup> kg/sqm-kg/qm	kg/scat.-kg/bte kg/box-kg/krt	scat/pal-bte/pal box/pal-krt/pal	mq/pal-m <sup>2</sup> /pal sqm/pal-qm/pal	kg/pal
Pavimento 34x34	9,00	11	1,270	16,73	21,25	48	60,96	1.020,00
Pavimento mix mosaico 34x34	9,00	11	1,270	16,73	21,25	48	60,96	1.020,00
Fascia 11x34	-	18	6,12 ml.	-	12,78	-	-	-
Angolo 11x11	-	4	-	-	0,92	-	-	-
Battiscopa 8x34	-	30	10,20 ml.	-	13,68	-	-	-
Torello gradino 5x34	-	6	2,04 ml.	-	6,00	-	-	-
Torello angolare 5x68	-	2	-	-	2,00	-	-	-

# filosofi 33,3x33,3 (13"x13")

PAVIMENTO | 33,3x33,3 | SPESSORE 9,5mm | 3 COLORI

01 - 1,774 m<sup>2</sup>/box



19590 SOCRATE (SABBIA)



19591 PLATONE (VERDE)



19592 DIOGENE (ROSA)

ROSONE (4 PEZZI PER COMPOSIZIONE) 33,3x33,3

21 - 4 PCS/BOX



10031 DIOGENE



10033 PLATONE

FASCIA 16,5x33,3

15 - 16 PCS/BOX



11623 PLATONE



11622 DIOGENE

ANGOLO 16,5x16,5

17 - 26 PCS/BOX



11523 PLATONE



11522 DIOGENE

LISTONE 3x36

02 - 54 PCS/BOX



10150 PLATONE



10151 DIOGENE



SOCRATE/DIOGENE

BATTISCOPA 8x33,3	GRADONE 33,3x35	ANGOLARE 35x35
02 - 30 PCS/BOX	31 - 4 PCS/BOX	39 - 2 PCS/BOX
18300 SOCRATE 18305 PLATONE 18310 DIOGENE	16100 SOCRATE 16101 PLATONE 16102 DIOGENE	16120 SOCRATE 16121 PLATONE 16122 DIOGENE

## IMBALLI E PESI

PACKINGS AND WEIGHTS • EMBALLAGES ET POIDS • VERPACKUNGEN UND GEWICHTE • EMBALAJES Y PESOS

MONOCOTTURA EN 14411/J Blla GL

FORMATO SIZE	pz/mq-pcs/m <sup>2</sup> pcs/sqm-stk/qm	pz/scat-pcs/bte pcs/box-stk/krt	mq/scat-m <sup>2</sup> /bte sqm/box-qm/krt	kg/mq-kg/m <sup>2</sup> kg/sqm-kg/qm	kg/scat-kg/bte kg/box-kg/krt	scat/pal-bte/pal box/pal-krt/pal	mq/pal-m <sup>2</sup> /pal sqm/pal-qm/pal	kg/pal
Pavimento 33,3x33,3	9	16	1,774	19,56	34,70	34	60,31	1.179,97
Fascia 16,5x33,3	-	16	5,33 ml.	-	16,40	-	-	-
Angolo 16,5x16,5	-	26	-	-	15,13	-	-	-
Composizione "4" 33,3x33,3	-	4	-	-	8,00	-	-	-
Listone 3x36	-	54	19,45 ml.	-	10,80	-	-	-
Gradone piastrella 33,3x35	-	4	-	-	10,00	-	-	-
Angolare piastrella 35x35	-	2	-	-	5,00	-	-	-
Battiscopa 8x33,3	-	30	10,00 ml.	-	15,42	-	-	-

# shakespeare 33,3x33,3 (13"x13")

PAVIMENTO | 33,3x33,3 | SPESSORE 9,5mm | 4 COLORI

01 - 1,774 m<sup>2</sup>/BOX



19550 AMLETO (BEIGE)



19551 LEAR (LEGNO)



19553 OTELLO (COTTO)



19554 LAERTE (PIETRA)

ANGOLO 33,3x33,3

43 - 4 PCS/BOX

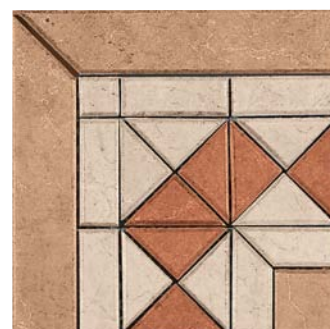

10115 OTELLO

FASCIA 33,3x33,3

26 - 4 PCS/BOX

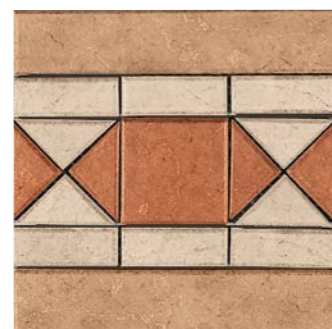

10110 OTELLO

ROSONE (4 PEZZI PER COMPOSIZIONE) 33,3x33,3

21 - 4 PCS/BOX



10030



10125 JAGO



10120 JAGO

RETTANGOLO DEC. 16,5x33,3

18 - 16 PCS/BOX



11618

QUADRO DECORATO 16,5x16,5

20 - 26 PCS/BOX

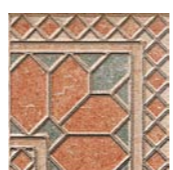

11518



AMLETO/OTELLO

BATTISCOPA 8x33,3	GRADONE 33,3x35	ANGOLARE 35x35
02 - 30 PCS/BOX	31 - 4 PCS/BOX	39 - 2 PCS/BOX
18260 AMLETO 18265 LEAR 18275 OTELLO 18280 LAERTE	16050 AMLETO 16051 LEAR 16052 OTELLO 16053 LAERTE	16060 AMLETO 16061 LEAR 16062 OTELLO 16063 LAERTE

## IMBALLI E PESI

PACKINGS AND WEIGHTS • EMBALLAGES ET POIDS • VERPACKUNGEN UND GEWICHTE • EMBALAJES Y PESOS

MONOCOTTURA EN 14411/J BIIa GL

FORMATO SIZE	pz/mq-pcs/m <sup>2</sup> pcs/sqm-stk/qm	pz/scat-pcs/bte pcs/box-stk/krt	mq/scat-m <sup>2</sup> /bte sqm/box-qm/krt	kg/mq-kg/m <sup>2</sup> kg/sqm-kg/qm	kg/scat-kg/bte kg/box-kg/krt	scat/pal-bte/pal box/pal-krt/pal	mq/pal-m <sup>2</sup> /pal sqm/pal-qm/pal	kg/pal
Pavimento 33,3x33,3	9	16	1,774	18,60	33,00	34	60,31	1.122,00
Fascia 16,5x33,3	-	16	5,33 ml.	-	16,40	-	-	-
Angolo 16,5x16,5	-	26	-	-	13,80	-	-	-
Fascia/angolo 33,3x33,3	-	4	-	-	10,00	-	-	-
Composizione "4" 33,3x33,3	-	4	-	-	10,00	-	-	-
Gradone 33,3x35	-	4	-	-	10,00	-	-	-
Angolare 35x35	-	2	-	-	5,00	-	-	-
Battiscopa 8x33,3	-	30	10 ml.	-	12,26	-	-	-

## principali informazioni e caratteristiche estetiche

main information and aesthetic characteristics on the technical requirements of floor tiles

les principales informations et caractéristiques esthétiques sur les standards techniques des carrelages de sol

die wichtigsten informationen zu den technischen anforderungen und haupteigenschaften der fliesen an geflieste wände und fusböden

las informaciones principales acerca de los requisitos técnicos de los pavimentos revestidos con azulejos

ОСНОВНАЯ ИНФОРМАЦИЯ О ТЕХНИЧЕСКИХ ТРЕБОВАНИЯХ К СТЕНАМ И ПОЛАМ ЭСТЕТИЧЕСКИЕ ХАРАКТЕРИСТИКИ ПЛИТКИ ОБЛИЦОВАННЫМ ПЛИТКОМ

关于铺砖墙壁和地板的技术要求的主要信息 瓷砖的主要美观特征



**RIVESTIMENTO**  
Wall tile  
Revêtement mural  
Wand  
Revestimiento pared  
Облицовка  
墙砖



**PAVIMENTO**  
Floor tile  
Sol  
Boden  
Piso  
Полы  
地砖



**PAVIMENTO DA BAGNO**  
Bathroom floor tile  
Sol salle de bains  
Boden für Bad  
Piso para baño  
Пол в ванной комнате  
浴室地砖



**RESISTENTE AL GELO**  
Frost resistant  
Résistant au gel  
Frostbeständig  
Resistencia al hielo  
Морозоустойчивый  
防冻



**RESISTENTE AGLI SBALZI TERMICI**  
Thermal shock resistant  
Résistant aux écarts thermiques  
Temperaturwechselbeständigkeit  
Resistencia a las variaciones térmicas  
Устойчивый к термоударам  
耐热度波动



**PRODOTTI CON PEZZI NON MODULARI DA POSARE IN DIAGONALE**  
Products with non-modular pieces which have to be laid diagonally  
Produits avec pièces non-modulaires à poser en diagonal  
Produkte mit nicht-modul Stuecke nur fuer Schraegverlegung empfohlen  
Productos con piezas non modulares para posa en diagonal  
Продукты с немодульными элементами для укладки по диагонали  
含有用于斜铺的非标准件的产品



**RETTIFICATO**  
Rectified  
Rectifié  
Rektifiziert  
Rectificado  
Ректифицированный  
磨边砖



**ALTA RESISTENZA**  
High resistance  
Haute résistance  
Hohe Festigkeit  
Alta resistencia  
Высокая сопротивляемость  
机械阻力高



**CLASSE DI RESISTENZA ALL'ABRASIONE SUPERFICIALE (DOVE INDICATO)**  
Class of resistance to surface abrasion (where indicated)  
Classe de résistance à l'abrasion superficielle (où mentionné)  
Oberflächenabrieb-Beanspruchungsgruppe (wo bezeichnet)  
Clase de resistencia a la abrasión superficial (cuando indicado)  
Класс сопротивляемости поверхности истиранию (где указано)  
耐表面磨蚀等级 (标示之处)



**RESISTENZA ALLO SCIVOLAMENTO**  
Slip resistance  
Résistance au glissement  
Bestimmung der Rutschhemmenden Eigenschaft  
Resistencia al deslizamiento  
Сопротивляемость скольжению  
防滑



**SPESORE MAGGIORATO**  
Increased thickness  
Épaisseur majorée  
Erhöhte Stärke  
Espesor aumentado  
Увеличенная толщина  
加厚厚度



**POSA CONSIGLIATA CON FUGA**  
Suggested laying with joint  
Pose conseillée avec joint  
Verlegung mit Fuge empfohlen  
Colocación aconsejada con junta  
Рекомендуется укладка со швом  
建议的留缝隙施工



**SÉRIGRAFIA**  
Screen printing  
Sérigraphie  
Serigraphie  
Serigrafia  
Сериграфия  
丝网印刷



**TERZO FUOCO**  
Third firing  
Troisième feu  
Dritt-Brand  
Cocción a tercer fuego  
Третий обжиг  
三次烧成



**QUARTO FUOCO**  
Fourth firing  
Quatrième feu  
Viert-Brand  
Cocción a cuarto fuego  
Четвертый обжиг  
四次烧成



**STRUTTURA A RILIEVO**  
Relief structure  
Structure en relief  
Reliefstruktur  
Estructura en relieve  
Рельефная структура  
浮凸结构



**METALLO**  
Metal  
Métal  
Metall  
Metal  
Металл  
金属



**DECORATO A MANO**  
Hand-painted  
Décové à la main  
Handgemalte  
Decorado a mano  
Декорирован вручную  
手工装饰



**LAPPATO**  
Semi-polished  
Polished  
Semi-Poli  
Anpoliert  
Pulido  
Полуполированный  
抛光



**DECORO INCOLLATO SU RETE**  
Mesh-mounted decors  
Décor collé sur filet  
Dekor auf Netz geklebt  
Decoro enmallado  
Клееный декор на сетке  
粘貼在网上的装饰件



**PREINCISO**  
Pre-cut  
Pré-incisé  
Voreingeschnitten  
Mosaico de pre-corte  
Предварительно надрезанный  
预割



**SUPERFICIE NATURALE**  
Natural surface  
Surface naturelle  
Natürliche Oberfläche  
Superficie natural  
Натуральная поверхность  
天然表面



**SUPERFICIE LUCIDA**  
Glossy surface  
Surface brillante  
Polierte Oberfläche  
Superficie brillante  
Глянцевая поверхность  
闪亮表面



**BURATTATO**  
Antique finish  
Vieilli  
Gealtert  
Efecto "anticato"  
Отшлифованный  
筛粉



**PIETRA NATURALE**  
Natural stone  
Pierre naturelle  
Naturstein  
Piedra natural  
Натуральный камень  
天然石



**VETRO**  
Glass  
Verre  
Glas  
Vidrio  
Стекло  
玻璃



**STAMPA AD ALTA RISOLUZIONE**  
High-definition printing  
Impression haute résolution  
Hochauflösungsdruck  
Impresión de alta resolución  
Печать с высоким разрешением  
高分辨率印刷



**LEVIGATO**  
Stain resistance  
Poli  
Poliert  
Pulido  
Полированный  
研磨

## caratteristiche generali











general characteristics - caractéristiques générales

allgemeine eigenschaften - características generales

ОБЩИЕ ХАРАКТЕРИСТИКИ - 综合特点

**GRES PORCELLANATO SMALTATO**

• GLAZED PORCELAIN TILES  
• GRÉS CÉRAME ÉMAILLÉ  
• GLASIERTES FEINSTEINZEUG  
• GRES PORCELÁNICO ESMALTADO  
• ГЛАЗУРОВАННЫЙ КЕРАМИЧЕСКИЙ ГРАНИТ  
• 玻化上釉砖

GRES PORCELLANATO SMALTATO		GLAZED PORCELAIN TILE • GRÉS CÉRAME ÉMAILLÉ • GLASIERTES FEINSTEINZEUG GRES PORCELÁNICO ESMALTADO • ГЛАЗУРОВАННЫЙ КЕРАМИЧЕСКИЙ ГРАНИТ • 釉面瓷磚		EN 14411/G Bla GL
	<b>CARATTERISTICHE TECNICHE</b> PHYSICAL PROPERTIES CARACTÉRISTIQUES TECHNIQUES TECHNISCHE DATEN CARACTERÍSTICAS TÉCNICAS ТЕХНИЧЕСКИЕ ХАРАКТЕРИСТИКИ 技术特征	<b>NORME</b> NORMS NORMES NORM NORMAS НОРМАТИВНЫЕ ТРЕБОВАНИЯ 标准	<b>VALORE PRESCRITTO DALLE NORME</b> REQUIRED STANDARDS VALEUR PRESCRITE PAR LES NORMES NORMVORGABE VALORES PREVISTOS POR LAS NORMAS ЗНАЧЕНИЯ НОРМАТИВНЫХ ТРЕБОВАНИЙ 标准规定值	<b>VALORE GARDENIA</b> GARDENIA VALUES VALEUR GARDENIA GARDENIA WERTE VALOR GARDENIA КЛАССИФИКАЦИЯ GARDENIA 数值
	<b>Assorbimento d'acqua</b> Water absorption Absorption d'eau Wasseraufnahme Absorción de agua Водопоглощение 吸水率	ISO 10545-3 (EN 99)	≤ 0,5%	Conforme Comply with Conforme Gemäß Conforme Соответствует 符合
	<b>Resistenza alla flessione</b> Bending strength Résistance à la flexion Biegezugfestigkeit Resistencia a la flexión Прочность на изгиб 抗挠强度	ISO 10545-4 (EN 100)	≥ 35 N/mm <sup>2</sup>	Conforme Comply with Conforme Gemäß Conforme Соответствует 符合
	<b>Durezza (Scala Mohs)</b> Hardness (Mohs scale) Dureté (échelle Mohs) Oberflächenhärte (nach Mohs) Durezza (crad) Твердость (шкала Мооса) 硬度 (莫氏)	(EN 101)	≥ 6	Conforme Comply with Conforme Gemäß Conforme Соответствует 符合
	<b>Coefficiente di dilatazione termica lineare</b> Coefficient of linear thermal expansion Coefficient de dilatation thermique linéaire Wärmeausdehnung Coeficiente de dilatación termica lineal Коэффициент теплового линейного расширения 线性热膨胀系数	ISO 10545-8 (EN 103)	≤ 9x10 <sup>-6</sup> °C <sup>-1</sup>	Conforme Comply with Conforme Gemäß Conforme Соответствует 符合
	<b>Resistenza agli sbalzi termici</b> Thermal shock resistance Résistance aux écarts de température Temperaturwechselbeständigkeit Resistencia a las variaciones térmicas Стойкость к тепловым ударам 耐热突变	ISO 10545-9 (EN 104)	Nessun campione deve presentare difetti visibili No sample must show visible defects Aucun échantillon ne doit présenter des défauts visibles Kein Exemplar soll sichtbare Schäden aufweisen Ninguna muestra debe presentar defectos visibles Ни на одном образце не должно быть видимых дефектов 任何样品都不得存在显眼缺陷	Conforme Comply with Conforme Gemäß Conforme Соответствует 符合
	<b>Resistenza al gelo</b> Frost resistance Résistance au gel Frostbeständigkeit Resistencia al hielo Морозостойкость 防冻	ISO 10545-12 (EN 202)	Nessun campione deve presentare rotture o alterazioni apprezzabili della superficie No sample must show breaks or evident alterations of the surface Les échantillons ne doivent pas présenter de ruptures ou d'altérations considérables de la surface Die Muster dürfen weder Bruch noch Schäden an der Oberfläche aufweisen Ninguna muestra debe presentar roturas o alteraciones apreciables de la superficie На поверхности образцов не должно быть сколов и заметных нарушений 任何样品都不得存在破裂或表面有可鉴别的变质	Conforme Comply with Conforme Gemäß Conforme Соответствует 符合
	<b>Resistenza all'attacco chimico</b> Chemical resistance Résistance à l'attaque chimique Beständigkeit gegen Chemikalien Resistencia química Химическая устойчивость 耐化学作用	ISO 10545-13 (EN 106)	Metodica di prova disponibile Testing method available Norme d'essais Prüfverfahren greifbar Metodologia de pruebas disponibles Имеющаяся методика проверки 备有测试方法论	Conforme Comply with Conforme Gemäß Conforme Соответствует 符合
	<b>Resistenza alle macchie</b> Stain resistance Résistance aux taches Fleckenbeständigkeit Resistencia a las manchas Стойкость к образованию пятен 防污	ISO 10545-14 (EN 122)	Classe 3 min Minimum class 3 Minimum classe 3 Mindestens Klasse 3 Mínimo categoría 3 Класс 3 мин 最小3级	Conforme Comply with Conforme Gemäß Conforme Соответствует 符合
	<b>Resistenza dei colori alla luce</b> Color resistance to light Résistance des couleurs à la lumière Lichtbeständigkeit Resistencia de los colores a la luz Светостойкость цветов 颜色耐光	DIN 51094	Non devono presentare apprezzabili variazioni di colore No noticeable color change Ne doivent pas présenter de variations importantes des couleurs Die Muster dürfen keine sichtbaren Farbveränderungen aufweisen No deben presentar variaciones apreciables de color Изменения цвета должны быть незначительны 不得存在可鉴别的颜色变化	Campioni inalterati in brillantezza e colore No change in brightness or color Echantillons inchangés en brillance et couleur Glanz und Farbe der Muster unverändert Muestras inalteradas en brillo y color Образцы неизменны по яркости и цвету 亮度与色彩不变的样品
	<b>Resistenza al Cavillo</b> <sup>1</sup> Crazing resistance <sup>1</sup> Résistance aux craquelures <sup>1</sup> Haarriß-Beständigkeit <sup>1</sup> Resistencia al cuarteo <sup>1</sup> Стойкость к образованию кракелюров <sup>1</sup> 耐瑕疵 <sup>1</sup>	ISO 10545-11 (EN 105)	Richiesta Demand Demande Nachfrage Demanda Требование 要求	Conforme Comply with Conforme Gemäß Conforme Соответствует 符合
	<b>Resistenza allo scivolamento</b> <sup>3</sup> Slip resistance <sup>3</sup> Résistance au glissement <sup>3</sup> Bestimmung der Rutschhemmenden Eigenschaft <sup>3</sup> Resistencia al deslizamiento <sup>3</sup> Сопротивление скольжению <sup>3</sup> 防滑 <sup>3</sup>	DIN 51130	6° ≤ α ≤ 10° = R9 10° < α ≤ 19° = R10 19° < α ≤ 27° = R11 27° < α ≤ 35° = R12 α > 35° = R13	Valore fornito a richiesta Value supplied on demand Donné fourni à la demande Wert auf Wunsch erteilt Valor dado a petición Значение дается по запросу 根据要求提供数值

# caratteristiche generali

general characteristics  
 caractéristiques générales  
 allgemeine eigenschaften  
 características generales  
 ОБЩИЕ ХАРАКТЕРИСТИКИ  
 综合特点



• BICOTTURA IN PASTA BIANCA MONOCALIBRO  
 • MONOCALIBER WHITE BODY DOUBLE-FIRING  
 • BICOISSON EN PÂTE BLANCHE D'UN SEUL CALIBRE  
 • WEISSSCHEIBIGE EINZELKALIBER ZWEIBRANDVERFAHREN  
 • BICOCCION EN PASTA BLANCA MONO-CALIBRE  
 • ПЛИТКА ДВОЙНОГО ОБЖИГА НА БЕЛОЙ МАССЕ ОДНОГО КАЛИБРА  
 • 单口白色坯体二次烧成

MONOCOTTURA		SINGLE FIRING • MONOCUISSON • EINBRANDVERFAHREN MONOCOCCION • ОДНОКРАТНЫЙ ОБЖИГ • 一次烧成		EN 14411/J BIIa GL	
	CARATTERISTICHE TECNICHE PHYSICAL PROPERTIES CARACTERISTIQUES TECHNIQUES TECHNISCHE DATEN CARACTERÍSTICAS TÉCNICAS ТЕХНИЧЕСКИЕ ХАРАКТЕРИСТИКИ 技术特征	NORME NORMS NORMES NORM NORMAS НОРМАТИВНЫЕ ТРЕБОВАНИЯ 标准	VALORE PRESCRITTO DALLE NORME REQUIRED STANDARDS VALEUR PRESCRITE PAR LES NORMES NORMVORGABE VALORES PREVISTOS POR LAS NORMAS ЗНАЧЕНИЯ НОРМАТИВНЫХ ТРЕБОВАНИЙ 标准规定值	VALORE GARDENIA GARDENIA VALUES VALEUR GARDENIA GARDENIA WERTE VALOR GARDENIA КЛАССИФИКАЦИЯ GARDENIA 数值	
	Assorbimento d'acqua Water absorption Absorption d'eau Wasseraufnahme Absorción de agua Водопоглощение 吸水率	ISO 10545-3 (EN 99)	3% ≤ E ≤ 6%	Conforme Comply with Conforme Gemäß Conforme Соответствует 符合	
	Resistenza alla flessione Bending strength Résistance à la flexion Biegezugfestigkeit Resistencia a la flexión Прочность на изгиб 抗挠强度	ISO 10545-4 (EN 100)	≥ 22 N/mm <sup>2</sup>	Conforme Comply with Conforme Gemäß Conforme Соответствует 符合	
	Durezza (Scala Mohs) Hardness (Mohs scale) Dureté (échelle Mohs) Oberflächenhärte (nach Mohs) Dureza (crad) Твердость (шкала Мооса) 硬度 (莫氏)	(EN 101)	≥ 5	Conforme Comply with Conforme Gemäß Conforme Соответствует 符合	
	Coefficiente di dilatazione termica lineare Coefficient of linear thermal expansion Coefficient de dilatation thermique linéaire Wärmeausdehnung Coeficiente de dilatación termica linear Коэффициент теплового линейного расширения 线性热膨胀系数	ISO 10545-8 (EN 103)	≤ 9x10 <sup>-6</sup> °C <sup>-1</sup>	Conforme Comply with Conforme Gemäß Conforme Соответствует 符合	
	Resistenza agli sbalzi termici Thermal shock resistance Résistance aux écarts de température Temperaturwechselbeständigkeit Resistencia a las variaciones térmicas Стойкость к тепловым ударам 耐热突变	ISO 10545-9 (EN 104)	Nessun campione deve presentare difetti visibili No sample must show visible defects Aucun échantillon ne doit présenter des défauts visibles Kein Exemplar soll sichtbare Schäden aufweisen Ninguna muestra debe presentar defectos visibles Ни на одном образце не должно быть видимых дефектов 任何样品都不得存在显眼缺陷	Conforme Comply with Conforme Gemäß Conforme Соответствует 符合	
	Resistenza all'attacco chimico Chemical resistance Résistance à l'attaque chimique Beständigkeit gegen Chemikalien Resistencia química Химическая устойчивость 耐化学作用	ISO 10545-13 (EN 106)	Metodica di prova disponibile Testing method available Norme d'essais Prüfverfahren greifbar Metodología de pruebas disponibles Имеющаяся методика проверки 备有测试方法论	Conforme Comply with Conforme Gemäß Conforme Соответствует 符合	
	Resistenza alle macchie Stain resistance Résistance aux taches Fleckenbeständigkeit Resistencia a las manchas Стойкость к образованию пятен 防污	ISO 10545-14 (EN 122)	Classe 3 min Minimum class 3 Minimum classe 3 Mindestens Klasse 3 Minimo categoria 3 Класс 3 мин 最小3级	Conforme Comply with Conforme Gemäß Conforme Соответствует 符合	
	Resistenza dei colori alla luce Color resistance to light Résistance des couleurs à la lumière Lichtbeständigkeit Resistencia de los colores a la luz Светостойкость цветов 颜色耐久	DIN 51094	Non devono presentare apprezzabili variazioni di colore No noticeable color change Ne doivent pas présenter de variations importantes des couleurs Die Muster dürfen keine sichtbaren Farbveränderungen aufweisen No deben presentar variaciones apreciables de color Изменения цвета должны быть незначительны 不得存在可鉴别的颜色变化	Campioni inalterati in brillantezza e colore No change in brightness or color Echantillons inchangés en brillance et couleur Glanz und Farbe der Muster unverändert Muestras inalteradas en brillo y color Образцы неизменны по яркости и цвету 亮度与色彩不变的样品	
	Resistenza al Cavillo <sup>1</sup> Crazing resistance <sup>1</sup> Résistance aux craquelures <sup>1</sup> Haarriß-Beständigkeit <sup>1</sup> Resistencia al cuarteo <sup>1</sup> Стойкость к образованию кракелюров <sup>1</sup> 耐瑕疵 <sup>1</sup>	ISO 10545-11 (EN 105)	Richiesta Demand Demande Nachfrage Demanda Требование 要求	Conforme Comply with Conforme Gemäß Conforme Соответствует 符合	

BICOTTURA		DOUBLE FIRING • BICOISSON • ZWEIBRANDVERFAHREN BICOCCION • ДВУКРАТНЫЙ ОБЖИГ • 二次烧成		EN 14411/L BIII GL	
	CARATTERISTICHE TECNICHE PHYSICAL PROPERTIES CARACTERISTIQUES TECHNIQUES TECHNISCHE DATEN CARACTERÍSTICAS TÉCNICAS ТЕХНИЧЕСКИЕ ХАРАКТЕРИСТИКИ 技术特征	NORME NORMS NORMES NORM NORMAS НОРМАТИВНЫЕ ТРЕБОВАНИЯ 标准	VALORE PRESCRITTO DALLE NORME REQUIRED STANDARDS VALEUR PRESCRITE PAR LES NORMES NORMVORGABE VALORES PREVISTOS POR LAS NORMAS ЗНАЧЕНИЯ НОРМАТИВНЫХ ТРЕБОВАНИЙ 标准规定值	VALORE GARDENIA GARDENIA VALUES VALEUR GARDENIA GARDENIA WERTE VALOR GARDENIA КЛАССИФИКАЦИЯ GARDENIA 数值	
	Assorbimento d'acqua Water absorption Absorption d'eau Wasseraufnahme Absorción de agua Водопоглощение 吸水率	ISO 10545-3 (EN 99)	> 10%	Conforme Comply with Conforme Gemäß Conforme Соответствует 符合	
	Resistenza alla flessione Bending strength Résistance à la flexion Biegezugfestigkeit Resistencia a la flexión Прочность на изгиб 抗挠强度	ISO 10545-4 (EN 100)	Media 15 N/mm <sup>2</sup> con spessore ≤ 7,5 mm   Media 12 N/mm <sup>2</sup> con spessore > 7,5 mm In average 15 N/mm <sup>2</sup> with thickness ≤ 7,5 mm   In average 12 N/mm <sup>2</sup> with thickness > 7,5 mm En moyenne 15 N/mm <sup>2</sup> avec épaisseur ≤ 7,5 mm   En moyenne 12 N/mm <sup>2</sup> avec épaisseur > 7,5 mm Durchschnittlich 15 N/mm <sup>2</sup> mit Staerke ≤ 7,5 mm   Durchschnittlich 12 N/mm <sup>2</sup> mit Staerke > 7,5 mm Media de 15 N/mm <sup>2</sup> con espesor ≤ 7,5 mm   Media de 12 N/mm <sup>2</sup> con espesor > 7,5 mm В среднем 15 N/mm <sup>2</sup> при толщине ≤ 7,5 mm   В среднем 12 N/mm <sup>2</sup> при толщине > 7,5 mm 平均15N/mm <sup>2</sup> , 厚度≤7.5 mm   平均12N/mm <sup>2</sup> , 厚度>7.5 mm	Conforme Comply with Conforme Gemäß Conforme Соответствует 符合	
	Durezza (Scala Mohs) Hardness (Mohs scale) Dureté (échelle Mohs) Oberflächenhärte (nach Mohs) Dureza (crad) Твердость (шкала Мооса) 硬度 (莫氏)	(EN 101)	≥ 3	Conforme Comply with Conforme Gemäß Conforme Соответствует 符合	
	Coefficiente di dilatazione termica lineare Coefficient of linear thermal expansion Coefficient de dilatation thermique linéaire Wärmeausdehnung Coeficiente de dilatación termica linear Коэффициент теплового линейного расширения 线性热膨胀系数	ISO 10545-8 (EN 103)	≤ 9x10 <sup>-6</sup> °C <sup>-1</sup>	Conforme Comply with Conforme Gemäß Conforme Соответствует 符合	
	Resistenza agli sbalzi termici Thermal shock resistance Résistance aux écarts de température Temperaturwechselbeständigkeit Resistencia a las variaciones térmicas Стойкость к тепловым ударам 耐热突变	ISO 10545-9 (EN 104)	Nessun campione deve presentare difetti visibili No sample must show visible defects Kein Exemplar muss sichtbare Schäden aufweisen Aucun échantillon ne doit présenter des défauts visibles Ninguna muestra debe presentar defectos visibles Ни на одном образце не должно быть видимых дефектов 任何样品都不得存在显眼缺陷	Conforme Comply with Conforme Gemäß Conforme Соответствует 符合	
	Resistenza all'attacco chimico Chemical resistance Résistance à l'attaque chimique Beständigkeit gegen Chemikalien Resistencia química Химическая устойчивость 耐化学作用	ISO 10545-13 (EN 106)	Metodica di prova disponibile Testing method available Norme d'essais Prüfverfahren greifbar Metodología de pruebas disponibles Имеющаяся методика проверки 备有测试方法论	Conforme Comply with Conforme Gemäß Conforme Соответствует 符合	
	Resistenza alle macchie Stain resistance Résistance aux taches Fleckenbeständigkeit Resistencia a las manchas Стойкость к образованию пятен 防污	ISO 10545-14 (EN 122)	Classe 3 min Minimum class 3 Minimum classe 3 Mindestens Klasse 3 Minimo categoria 3 Класс 3 мин 最小3级	Conforme Comply with Conforme Gemäß Conforme Соответствует 符合	
	Resistenza dei colori alla luce Color resistance to light Résistance des couleurs à la lumière Lichtbeständigkeit Resistencia de los colores a la luz Светостойкость цветов 颜色耐久	DIN 51094	Non devono presentare apprezzabili variazioni di colore No noticeable color change Ne doivent pas présenter de variations importantes des couleurs Die Muster dürfen keine sichtbaren Farbveränderungen aufweisen No deben presentar variaciones apreciables de color Изменения цвета должны быть незначительны 不得存在可鉴别的颜色变化	Campioni inalterati in brillantezza e colore No change in brightness or color Echantillons inchangés en brillance et couleur Glanz und Farbe der Muster unverändert Muestras inalteradas en brillo y color Образцы неизменны по яркости и цвету 亮度与色彩不变的样品	
	Resistenza al Cavillo <sup>1</sup> Crazing resistance <sup>1</sup> Résistance aux craquelures <sup>1</sup> Haarriß-Beständigkeit <sup>1</sup> Resistencia al cuarteo <sup>1</sup> Стойкость к образованию кракелюров <sup>1</sup> 耐瑕疵 <sup>1</sup>	ISO 10545-11 (EN 105)	Richiesta Demand Demande Nachfrage Demanda Требование 要求	Conforme Comply with Conforme Gemäß Conforme Соответствует 符合	

<sup>1</sup> Certi effetti decorativi su decori e pezzi speciali possono provocare una tendenza al cavillo, quindi si intendono non soggetti alla prescrizione.

<sup>1</sup> Certain decorative effects on accents and trim pieces can produce a tendency to craze, so they are not covered by the standard.

<sup>1</sup> Certains effets décoratifs sur décors et pièces spéciales sont susceptibles de faire apparaître des craquelures, ils ne sont donc pas soumis à cette norme.

<sup>1</sup> Gewisse Dekorationseffekte auf Dekor- und Formteile können zur Haarrißbildung neigen und müssen daher als normabweichende Ausnahme betrachtet werden.

<sup>1</sup> Ciertos efectos decorativos sobre decoraciones y piezas especiales pueden provocar una tendencia al cuarteado, por lo tanto no están sujetos a la prescripción.

<sup>1</sup> Некоторые декоративные эффекты на декоре и специальных изделиях могут вызвать тенденцию к кракелюрам, следовательно, они не подлежат рекомендации.

<sup>1</sup> 装饰件及特殊件上的某些装饰效果可能会引起争辩，因此不纳在规定范围内。





RIVESTIMENTI - WALL TILE



**COD. 6001059**  
BISTRO' 20x20



**COD. 6001060**  
FILOSOFI 25x41



**COD. 6001093**  
CULLA VELVET 20x50



**COD. 6001062**  
LE CRETE DI PIAN  
DELLA FORNACE 20x20



**COD. 6001092**  
PULSAR 20X33,3 / NIRVANA 25x41

PAVIMENTI - FLOOR TILE



**COD. 6001052**  
CEMENTO 34x34



**COD. 6001054**  
FILOSOFI 33,3x33,3 - 41x41



**COD. 6001051**  
FLORENCE 34x34



**COD. 6001053**  
MINIMAL 30,5x60,5 - 60,5x60,5



**COD. 6001056**  
SHAKESPEARE 33,3x33,3



**COD. 6001091**  
CULLA PERLA 50X50



**COD. 6001089**  
CULLA LUMINOR 50X50

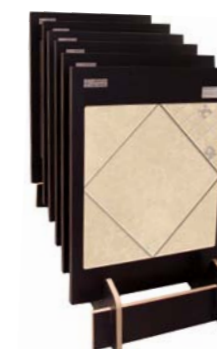

**COD. 6001095**  
CULLA KARMA / TEXTILE 41x41



Progetto, direzione e coordinamento a cura di Ufficio Marketing Ceramiche Gardenia Orchidea

Publicato da Ceramiche Gardenia Orchidea S.p.A.  
Via Canaletto, 27  
41042 SPEZZANO DI FIORANO (MO)

Pubblicazione Gennaio 2010

"La proprietà intellettuale del presente catalogo è riservata per tutti i Paesi. La traduzione, riproduzione, memorizzazione elettronica e l'adattamento totale o parziale e con qualsiasi mezzo (compresi microfilm e le copie fotostatiche) dei suoi contenuti comporta la violazione dei diritti di copyright di Ceramiche Gardenia Orchidea S.p.A. I prodotti raffigurati nelle immagini del presente catalogo sono protetti secondo la normativa vigente in materia di proprietà industriale".

Project management and coordination by Ceramiche Gardenia Orchidea Marketing Office

Published by Ceramiche Gardenia Orchidea S.p.A.  
Via Canaletto, 27  
41042 SPEZZANO DI FIORANO (MO)

Copyright January 2010

"All the intellectual property rights of this catalogue are reserved in all countries. Translation, reproduction in print or electronic form, and adaptation, in whole or in part, using any means (including microfilm and photocopy formats) of the contents of the said catalogue constitute a violation of Ceramiche Gardenia Orchidea S.p.A.'s copyright. The products featured in the photographs in this catalogue are protected by current industrial property legislation."

- I colori possono risultare falsati dai procedimenti litografici.
- The colours could be altered by the lithographic printing process.
- Les couleurs peuvent résulter faussées par les procédés lithographiques.
- Durch die Lithographie können farbliche Täuschungen entstehen.
- Los colores pueden resultar falseados por los procedimientos litográficos
- ЦВЕТА МОГУТ БЫТЬ ИСКАЖЕНЫ ВСЛЕДСТВИЕ ЛИТОГРАФИЧЕСКОЙ ОБРАБОТКИ.
- 颜色可通过平版印刷处理而改变



Spezzano (Mo) Italy - Tel. +39.0536.849611 - Fax +39.0536.849856  
[www.gardeniaorchidea.com](http://www.gardeniaorchidea.com) e-mail: [info@gardenia.it](mailto:info@gardenia.it)

cod. 6002100