



VERSACE
CERAMIC DESIGN

COMPLEMENTI D'ARREDO CHE COMPLETANO IL
PROGETTO VERSACE CERAMIC DESIGN.

Furnishing accessories which complete the Versace Ceramic Design project.

Collection d'accessoires de décoration qui complete le projet Versace Ceramic Design.

Eine Kollektion aus Ausstattungszubehör, die das Projekt Versace Ceramic Design vervollständigen.

Accesorios de decoración que completan el proyecto Versace Ceramic Design.



PALACE



VERSACE
CERAMIC DESIGN

VERSACE
CERAMIC DESIGN

VERSACE
CERAMIC DESIGN

COMPLEMENTI D'ARREDO FORTEMENTE IDENTIFICATIVI,
RICERCATI NEL DESIGN E NELLA STRUTTURA.

• **ACCESSORI BAGNO** pag. 08-15
• bathroom accessories

• **RUBINETTI E ACCESSORI
COORDINATI** pag. 18-25
• faucet and matching accessories

• **APPLIQUES** pag. 28-33
• appliques

• **MANIGLIE** pag. 34-35
• handles

• **ELEMENTI ARCHITETTONICI** pag. 36-37
• architectural elements

Line of highly identifying furnishing accessories, painstakingly researched in both design and structure.

Accessoires de décoration se distinguant fortement, recherchés dans le design et dans la structure.

Kollektion aus ausgesprochen identifizierenden Ausstattungszubehör, deren Design und Struktur Gewährtheit zeigen.

Accesorios de decoración muy identificativos, con un elegante diseño y una estructura refinada.

VERSACE
CERAMIC DESIGN

ACCESSORI BAGNO



bathroom accessories

VERSACE
CERAMIC DESIGN



art. 6810035 FREGIO MEDUSA Fusioni di bronzo, finitura palladio, vetro acidato

MEDUSA MEDALLION Die-cast bronze, palladium finish, acid-etched glass



art. 6810038 COPPIA APPENDIABITI Fusioni di bronzo, finitura palladio, vetro acidato

PAIRED CLOTHES KNOBS Die-cast bronze, palladium finish, acid-etched glass



art. 6810085 COPPIA POMOLI Fusioni di bronzo, finitura palladio, vetro acidato sfaccettato. Senza perno per apertura e chiusura

PAIRED ALL-PURPOSE KNOBS (NO SPINDLE) Die-cast bronze, palladium finish, faceted acid-etched glass



art. 6810033 SCATOLA PORTA KLEENEX Fusioni di bronzo, finitura palladio

NAPKIN DISPENSER Die-cast bronze, palladium finish



art. 6810032 PORTASAPONE Fusioni di bronzo, finitura palladio, vaschetta interna in vetro acidato

SOAP HOLDER Die-cast bronze, palladium finish, acid-etched glass interior



art. 6810030 SCATOLA Fusioni di bronzo, finitura palladio, vetro acidato

JAR Die-cast bronze, palladium finish, acid-etched glass



art. 6810034 COPPA Fusioni di bronzo, finitura palladio, vetro acidato

CUP Die-cast bronze, palladium finish, acid-etched glass



art. 6810031 SCATOLA Fusioni di bronzo, finitura palladio, interno e coperchio in vetro acidato

JAR Die-cast bronze, palladium finish, acid-etched glass interior and cover



art. 6810029 PORTABICCHIERE Fusioni di bronzo, finitura palladio, bicchiere in vetro acidato

BEAKER HOLDER Die-cast bronze, palladium finish, acid-etched glass



art. 6810013 PORTASAPONE Fusioni di bronzo, dor. oro 24K, vaschetta interna in vetro acidato
 SOAP HOLDER Die-cast bronze, 24K gold plated, acid-etched glass interior



art. 6810019 COPPIA APPENDIABITI Fusioni di bronzo, dor. oro 24K, vetro acidato
 PAIRED CLOTHES KNOBS Die-cast bronze, 24K gold plated, acid-etched glass



art. 6810076 COPPIA POMOLI Fusioni di bronzo, dor. oro 24K, vetro acidato sfaccettato. Senza perno per apertura e chiusura
 PAIRED ALL-PURPOSE KNOBS (NO SPINDLE) Die-cast bronze, 24K gold plated, faceted acid-etched glass



art. 6810014 SCATOLA PORTA KLEENEX Fusioni di bronzo, dor. oro 24K
 NAPKIN DISPENSER Die-cast bronze, 24K gold plated



art. 6810016 FREGIO MEDUSA Fusioni di bronzo, dor. oro 24K, vetro acidato
 MEDUSA MEDALLION Die-cast bronze, 24K gold plated, acid-etched glass



oro

VERSACE
 CERAMIC DESIGN



art. 6810011 SCATOLA Fusioni di bronzo, dor. oro 24K, vetro acidato
 JAR Die-cast bronze, 24K gold plated, acid-etched glass



art. 6810015 COPPA Fusioni di bronzo, dor. oro 24K, vetro acidato
 CUP Die-cast bronze, 24K gold plated, acid-etched glass



art. 6810012 SCATOLA Fusioni di bronzo, dor. oro 24K, interno e coperchio in vetro acidato
 JAR Die-cast bronze, 24K gold plated, acid-etched glass interior and cover



art. 6810010 PORTABICCHIERE Fusioni di bronzo, dor. oro 24K, bicchiere in vetro acidato
 BEAKER HOLDER Die-cast bronze, 24K gold plated, acid-etched glass



art. 6810037 PORTAROTOLO
Fusioni di bronzo, finitura palladio
PAPER ROLL HOLDER
Die-cast bronze, palladium finish



art. 6810080 PORTA ASCIUGAMANI AD ANELLO
Fusioni di bronzo, finitura palladio
RING TOWEL HOLDER
Die-cast bronze, palladium finish



art. 6810036 PORTASAPONE Fusioni di bronzo,
finitura palladio, vetro acidato
SOAP DISH Die-cast bronze,
palladium finish, acid-etched glass



art. 6810078 PORTASCOPINO DA PARETE
Fusioni di bronzo,
finitura palladio,
inserti in vetro acidato,
interno in vetro
WALL BRUSH HOLDER
Die-cast bronze, palladium finish,
acid-etched glass inserts,
glass interior



art. 6810028 PORTA ASCIUGAMANI Fusioni di bronzo,
finitura palladio, lunghezza 60 cm
TOWEL HOLDER Die-cast bronze,
palladium finish, width 60 cm



art. 6810027 PORTA ASCIUGAMANI Fusioni di bronzo,
finitura palladio, lunghezza 45 cm
TOWEL HOLDER Die-cast bronze,
palladium finish, width 45 cm



art. 6810026 PORTA ASCIUGAMANI Fusioni di bronzo,
finitura palladio, lunghezza 30 cm
TOWEL HOLDER Die-cast bronze,
palladium finish, width 30 cm



art. 6810084 MENSOLA Cristallo, fusioni di bronzo,
finitura palladio, lunghezza 60 cm
SHELF Crystal, die-cast bronze,
palladium finish, width 60 cm



art. 6810096 MENSOLA Cristallo, fusioni di bronzo,
finitura palladio, lunghezza 45 cm
SHELF Crystal, die-cast bronze,
palladium finish, width 45 cm



art. 6810097 MENSOLA Cristallo, fusioni di bronzo,
finitura palladio, lunghezza 30 cm
SHELF Crystal, die-cast bronze,
palladium finish, width 30 cm

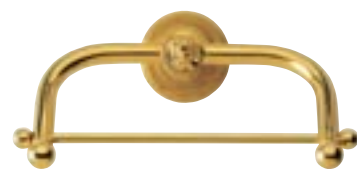

art. 6810018 PORTAROTOLO
Fusioni di bronzo, dor. oro 24K
PAPER ROLL HOLDER
Die-cast bronze, 24K gold plated



art. 6810079 PORTA ASCIUGAMANI AD ANELLO
Fusioni di bronzo, dor. oro 24K
RING TOWEL HOLDER
Die-cast bronze, 24K gold plated



art. 6810017 PORTASAPONE Fusioni di bronzo,
dor. oro 24K, vetro acidato
SOAP DISH Die-cast bronze,
24K gold plated, acid-etched glass



art. 6810077 PORTASCOPINO DA PARETE
Fusioni di bronzo,
dor. oro 24K,
inserti in vetro acidato,
interno in vetro
WALL BRUSH HOLDER
Die-cast bronze, 24K gold plated,
acid-etched glass inserts,
glass interior



art. 6810009 PORTA ASCIUGAMANI Fusioni di bronzo,
dor. oro 24K, lunghezza 60 cm
TOWEL HOLDER Die-cast bronze,
24K gold plated, width 60 cm



art. 6810008 PORTA ASCIUGAMANI Fusioni di bronzo,
dor. oro 24K, lunghezza 45 cm
TOWEL HOLDER Die-cast bronze,
24K gold plated, width 45 cm



art. 6810007 PORTA ASCIUGAMANI Fusioni di bronzo,
dor. oro 24K, lunghezza 30 cm
TOWEL HOLDER Die-cast bronze,
24K gold plated, width 30 cm



art. 6810081 MENSOLA Cristallo, fusioni di bronzo,
dor. oro 24K, lunghezza 60 cm
SHELF Crystal, die-cast bronze,
24K gold plated, width 60 cm



art. 6810094 MENSOLA Cristallo, fusioni di bronzo,
dor. oro 24K, lunghezza 45 cm
SHELF Crystal, die-cast bronze,
24K gold plated, width 45 cm



art. 6810095 MENSOLA Cristallo, fusioni di bronzo,
dor. oro 24K, lunghezza 30 cm
SHELF Crystal, die-cast bronze,
24K gold plated, width 30 cm

RUBINETTI E ACCESSORI COORDINATI



faucets and matching accessories

VERSACE
CERAMIC DESIGN



art. 6810093
BRACCIO DOCCIA Fusioni di bronzo,
finiture cromo/oro 24k

SHOWER ARM Die-cast bronze,
chrome/24k gold finish



art. 6810099
RUBINETTO SINGOLO
Fusioni di bronzo,
finiture cromo/oro 24k

SINGLE FAUCET
Die-cast bronze,
chrome/24k gold finish



art. 6810065
MISCELATORE TERMOSTATICO
A DUE USCITE
Fusioni di bronzo,
finiture cromo/oro 24k

TWO-OUTLET
THERMOSTATIC MIXER
Die-cast bronze,
chrome/24k gold finish.



art. 6810041
GRUPPO VASCA AD INCASSO CON
DUPLEX E COLONNA EROGATORE
AL TROPPO PIENO
Fusioni di bronzo, finiture cromo/oro 24k.
Pezzi per il montaggio inclusi

DROP-IN BATHTUB SET WITH DUPLEX UNIT
AND FAUCET COLUMN OVERFLOW
Die-cast bronze,chrome/24k gold finish.
Assembly parts included



art. 6810119
DUPLEX
Fusioni di bronzo,
finiture cromo/oro 24k

DUPLEX UNIT
Die-cast bronze,
chrome/24k gold finish



art. 6810122
DEVIATORE
Fusioni di bronzo,
finiture cromo/oro 24k.

FLOW DIVERTER
Die-cast bronze,
chrome/24k gold finish.



art. 6810042
GRUPPO VASCA ESTERNO
Fusioni di bronzo,
finiture cromo/oro 24k.
Pezzi per il montaggio inclusi

OUTSIDE BATHTUB UNIT
Die-cast bronze,
chrome/24k gold finish.
Assembly parts included



art. 6810039
BATTERIA BIDET A TRE FORI Fusioni di bronzo,
finiture cromo/oro 24k. Pezzi per il montaggio inclusi

THREE-HOLE BIDET SET Die-cast bronze,
chrome/24k gold finish. Assembly parts included



art. 6810091
BATTERIA LAVABO A TRE FORI Fusioni di bronzo,
finiture cromo/oro 24k. Pezzi per il montaggio inclusi

THREE-HOLE WASHBASIN SET Die-cast bronze,
chrome/24k gold finish. Assembly parts included



art. 6810092
MONOFORO BIDET Fusioni di bronzo,
finiture cromo/oro 24k. Pezzi per il montaggio inclusi

SINGLE HOLE SET Die-cast bronze,
chrome/24k gold finish. Assembly parts included



art. 6810040
GRUPPO BORDO VASCA QUATTRO
FORI CON DOCCIA ESTRAIBILE E
COLONNA EROGATORE AL
TROPPO PIENO
Fusioni di bronzo,
finiture cromo/oro 24k.
Pezzi per il montaggio inclusi

FOUR-HOLE BATHTUB SIDE SET
WITH PULL-OUT SHOWER HOSE AND
FAUCET COLUMN OVERFLOW UNIT
Die-cast bronze,
chrome/24k gold finish.
Assembly parts included





art. 6810052
BRACCIO DOCCIA
Fusioni di bronzo, dor. oro 24K

SHOWER ARM
Die-cast bronze, 24K gold plated



art. 6810098
RUBINETTO SINGOLO
Fusioni di bronzo,
dor. oro 24K

SINGLE FAUCET
Die-cast bronze,
24K gold plated



art. 6810053
MISCELATORE TERMOSTATICO
A DUE USCITE
Fusioni di bronzo, dor. oro 24K

TWO-OUTLET
THERMOSTATIC MIXER
Die-cast bronze,
24K gold plated



art. 6810058
GRUPPO VASCA AD INCASSO
CON DUPLEX E COLONNA
EROGATORE AL TROPPO PIENO
Fusioni di bronzo, dor. oro 24K
Pezzi per il montaggio inclusi

DROP-IN BATHTUB SET WITH
DUPLEX UNIT AND
FAUCET COLUMN OVERFLOW
Die-cast bronze, 24K gold plated
Assembly parts included



art. 6810126
DUPLEX
Fusioni di bronzo,
dor. oro 24K

DUPLEX UNIT
Die-cast bronze,
24K gold plated



art. 6810133
DEVIATORE
Fusioni di bronzo,
dor. oro 24K

FLOW DIVERTER
Die-cast bronze,
24K gold plated



art. 6810059
GRUPPO VASCA ESTERNO
Fusioni di bronzo,
dor. oro 24K
Pezzi per il montaggio inclusi

OUTSIDE BATHTUB UNIT
Die-cast bronze,
24K gold plated
Assembly parts included



art. 6810055
BATTERIA BIDET A TRE FORI Fusioni di bronzo,
dor. oro 24K. Pezzi per il montaggio inclusi

THREE-HOLE BIDET SET Die-cast bronze,
24K gold plated. Assembly parts included



art. 6810056
BATTERIA LAVABO A TRE FORI Fusioni di bronzo,
dor. oro 24K. Pezzi per il montaggio inclusi

THREE-HOLE WASHBASIN SET Die-cast bronze,
24K gold plated. Assembly parts included



art. 6810054
MONOFORO BIDET Fusioni di bronzo,
dor. oro 24K. Pezzi per il montaggio inclusi

SINGLE HOLE BIDET SET Die-cast bronze,
24K gold plated. Assembly parts included



art. 6810057
GRUPPO BORDO VASCA QUATTRO
FORI CON DOCCIA ESTRAIBILE E
COLONNA EROGATORE AL
TROPPO PIENO
Fusioni di bronzo, dor.oro 24k
Pezzi per il montaggio inclusi

FOUR-HOLE BATHTUB SIDE SET
WITH PULL-OUT SHOWER HOSE AND
FAUCET COLUMN OVERFLOW UNIT
Die-cast bronze, 24K gold plated
Assembly parts included



art. 6810064 PORTASCOPINO
Fusioni di bronzo,
finiture cromo/oro 24k

BRUSH HOLDER
Die-cast bronze,
chrome/24k gold finish



art. 6810088 PORTAROTOLO Fusioni di bronzo,
finiture cromo/oro 24k

PAPER ROLL HOLDER Die-cast bronze,
chrome/24k gold finish



art. 6810087 PORTA ABITI Fusioni di bronzo,
finiture cromo/oro 24k

CLOTHES HANGER Die-cast bronze,
chrome/24k gold finish



art. 6810062 PORTABICCHIERE DA PARETE Fusioni di bronzo,
finiture cromo/oro 24k, vetro acidato

WALL CUP HOLDER Die-cast bronze,
chrome/24k gold finish, acid-etched glass



art. 6810060 PORTASAPONE A PARETE Fusioni di bronzo,
finiture cromo/oro 24k, vetro acidato

WALL SOAP HOLDER Die-cast bronze,
chrome/24k gold finish, acid-etched glass

NOVITÀ



art. 6810148 COPPIA POMOLI Fusioni di bronzo, finiture cromo, cm 3,2

PAIRED ALL PURPOSE KNOBS (NO SPINDLE)
Die-cast bronze, chrome finish, 3.2 cm



art. 6810146 COPPIA POMOLI Fusioni di bronzo, finiture cromo, cm 2,6

PAIRED ALL PURPOSE KNOBS (NO SPINDLE)
Die-cast bronze, chrome finish, 2.6 cm



NOVITÀ



art. 6810106 PORTA SAPONE LIQUIDO DA APPOGGIO
Fusioni di bronzo, finiture cromo/oro 24k

LIQUID SOAP DISPENSER
Die-cast bronze, chrome/24k gold finish



art. 6810130 PORTA SAPONE LIQUIDO DA MURO
Fusioni di bronzo, finiture cromo/oro 24k

WALL-MOUNTED LIQUID SOAP DISPENSER
Die-cast bronze, chrome/24k gold finish



art. 6810090 PORTA ASCIUGAMANI Fusioni di bronzo,
finiture cromo/oro 24k, lunghezza 60 cm

TOWEL HOLDER Die-cast bronze,
chrome/24k gold finish, width 60 cm



art. 6810063 PORTA ASCIUGAMANI Fusioni di bronzo,
finiture cromo/oro 24k, lunghezza 40 cm

TOWEL HOLDER Die-cast bronze,
chrome/24k gold finish, width 40 cm



art. 6810089 PORTA ASCIUGAMANI AD ANELLO
Fusioni di bronzo, finiture cromo/oro 24k

RING TOWEL HOLDER Die-cast bronze, chrome/24k gold finish



art. 6810061 PORTASPUGNA Fusioni di bronzo,
finiture cromo/oro 24k

SPONGE HOLDER
Die-cast bronze, chrome/24k gold finish



art. 6810050 PORTASCOPINO
Fusioni di bronzo,
dor. oro 24k

BRUSH HOLDER
Die-cast bronze,
24K gold plated



art. 6810049 PORTAROTOLO
Fusioni di bronzo, dor. oro 24k

PAPER ROLL HOLDER
Die-cast bronze, 24K gold plated



art. 6810051 PORTA ABITI
Fusioni di bronzo, dor. oro 24k

CLOTHES HANGER
Die-cast bronze, 24K gold plated



art. 6810045 PORTABICCHIERE DA PARETE
Fusioni di bronzo,
dor. oro 24k, vetro acidato

WALL CUP HOLDER Die-cast bronze,
24K gold plated, acid-etched glass



art. 6810043 PORTASAPONE A PARETE
Fusioni di bronzo,
dor. oro 24k, vetro acidato

WALL SOAP HOLDER Die-cast bronze,
24K gold plated, acid-etched glass

NOVITÀ



art. 6810147 COPPIA POMOLI Fusioni di bronzo, dor. oro 24k, cm 3,2

PAIRED ALL PURPOSE KNOBS (NO SPINDLE)
Die-cast bronze, 24k gold plated, 3.2 cm



art. 6810145 COPPIA POMOLI Fusioni di bronzo, dor. oro 24k, cm 2,6

PAIRED ALL PURPOSE KNOBS (NO SPINDLE)
Die-cast bronze, 24k gold plated, 2.6 cm



art. 6810105 PORTA SAPONE LIQUIDO DA APPOGGIO
Fusioni di bronzo, dor. oro 24k

LIQUID SOAP DISPENSER
Die-cast bronze, 24k gold plated



art. 6810109 PORTA SAPONE LIQUIDO DA MURO
Fusioni di bronzo, dor. oro 24k

WALL-MOUNTED LIQUID SOAP DISPENSER
Die-cast bronze, 24k gold plated

NOVITÀ



art. 6810048 PORTA ASCIUGAMANI Fusioni di bronzo,
dor. oro 24k, lunghezza 60 cm

TOWEL HOLDER Die-cast bronze,
24K gold plated, width 60 cm



art. 6810047 PORTA ASCIUGAMANI Fusioni di bronzo,
dor. oro 24k, lunghezza 40 cm

TOWEL HOLDER Die-cast bronze,
24K gold plated, width 40 cm



art. 6810046 PORTA ASCIUGAMANI AD ANELLO
Fusioni di bronzo, dor. oro 24k

RING TOWEL HOLDER Die-cast bronze, 24K gold plated

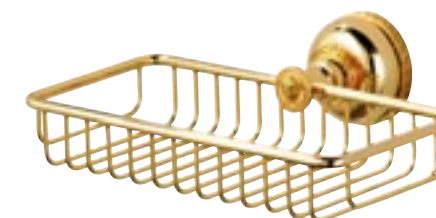

art. 6810044 PORTASPUGNA Fusioni di bronzo,
dor. oro 24k

SPONGE HOLDER Die-cast bronze,
24K gold plated



A P P L I Q U E e

M A N I G L I E

appliques and handles



VERSACE
CERAMIC DESIGN



art. 6810083/O (Europa)
art. 6810083/E (USA-Australia)

APPLIQUE SNODO
 Fusioni di bronzo, finitura palladio

ARTICULATED WALL LAMP
 Die-cast bronze, palladium finish



art. 6810021/O (Europa)
art. 6810021/E (USA-Australia)

APPLIQUE
 Fusioni di bronzo, finitura palladio

WALL LAMP
 Die-cast bronze, palladium finish



art. 6810072/A PARALUME
 Tessuro Bemberg,
 finitura argento
(per applique singola)

LAMP SHADE
 Bemberg fabric, silver trim
(for single wall lamp)



art. 6810025/O PARALUME
 Tessuro Bemberg,
 finitura argento
(per applique singola)

LAMP SHADE
 Bemberg fabric, silver trim
(for single wall lamp)



VERSACE
 CERAMIC DESIGN



art. 6810023/O (Europa)
art. 6810023/E (USA-Australia)

APPLIQUE CONCHIGLIA
 Fusioni di bronzo, finitura palladio

SHELL WALL LAMP
 Die-cast bronze, palladium finish



art. 6810072/O PARALUME
 Tessuro Bemberg,
 finitura argento
(per applique doppia)

LAMP SHADE
 Bemberg fabric,
 silver trim
(for double wall lamp)

NOTA/NOTE:
 APPLIQUE/APPLIQUES
 art./O: Europa
 art./E: USA Australia

PARALUMI/LAMP SHADES
 art./O: per applique doppia
 for double wall lamp
 art./A: per applique singola
 for single wall lamp



art. 6810002/O (Europa)
art. 6810002/E (USA -Australia)

APPLIQUE
Fusioni di bronzo, dor. oro 24K,
h 53 cm

WALL LAMP
Die-cast bronze, 24K gold plated,
h 53 cm



art. 6810003/O (Europa)
art. 6810003/E (USA-Australia)

APPLIQUE
Fusioni di bronzo, dor. oro 24K,
legno laccato nero, h 53 cm

WALL LAMP
Die-cast bronze, 24K gold plated,
black lacquered wood, h 53 cm



art. 6810022/O (Europa)
art. 6810022/E (USA-Australia)

APPLIQUE CONCHIGLIA
Fusioni di bronzo, dor. oro 24K, h 40 cm

SHELL WALL LAMP
Die-cast bronze, 24K gold plated, h 40 cm



art. 6810005/O PARALUME
Seta decoro barocchino,
fondo azzurro
(per applique doppia)

LAMP SHADE
Silk barocchino decor
blue background
(for double wall lamp)



art. 6810006/O PARALUME
Seta decoro meduse oro,
finitura nera
(per applique doppia)

LAMP SHADE
Silk gold medusa decor,
black trim
(for double wall lamp)

NOTA/NOTE:
APPLIQUE/APPLIQUES
art./O: Europa
art./E: USA Australia

PARALUMI/LAMP SHADES
art./O: per applique doppia
for double wall lamp
art./A: per applique singola
for single wall lamp



art. 6810082/O (Europa)
art. 6810082/E (USA-Australia)
 APPLIQUE SNODO Fusioni di bronzo, dor. oro 24K
 ARTICULATED WALL LAMP Die-cast bronze, 24K gold plated



art. 6810001/O (Europa)
art. 6810001/E (USA-Australia)
 APPLIQUE Fusioni di bronzo, dor. oro 24K
 WALL LAMP Die-cast bronze, 24K gold plated

NOTA/NOTE:
 APPLIQUE/APPLIQUES
 art./O: Europa
 art./E: USA Australia

PARALUMI/LAMPSHADES
 art./O: per applique doppia
 for double wall lamp
 art./A: per applique singola
 for single wall lamp



o r o

VERSACE
 CERAMIC DESIGN



art. 6810020/O PARALUME Tessuto Bemberg, finitura oro
 (per applique singola)
 LAMPSHADE Bemberg fabric, gold trim
 (for single wall lamp)



art. 6810004/O PARALUME Seta decoro barocchino, fondo oro
 (per applique singola)
 LAMPSHADE Silk barocchino decor, gold background
 (for single wall lamp)



art. 6810005/A PARALUME Seta decoro barocchino, fondo azzurro
 (per applique singola)
 LAMPSHADE Silk barocchino decor, blue background
 (for single wall lamp)



art. 6810006/A PARALUME Seta decoro meduse oro, finitura nera
 (per applique singola)
 LAMPSHADE Silk gold medusa decor, black trim
 (for single wall lamp)



art. 6810142 MANIGLIA FINESTRA
Fusioni di bronzo,
finiture cromo/oro 24k

WINDOW HANDLE
Die-cast bronze,
chrome/24k gold finish



art. 6810143 REGGITENDA
Fusioni di bronzo,
dor. oro 24k

CURTAIN STOP
Die-cast bronze,
24k gold plated

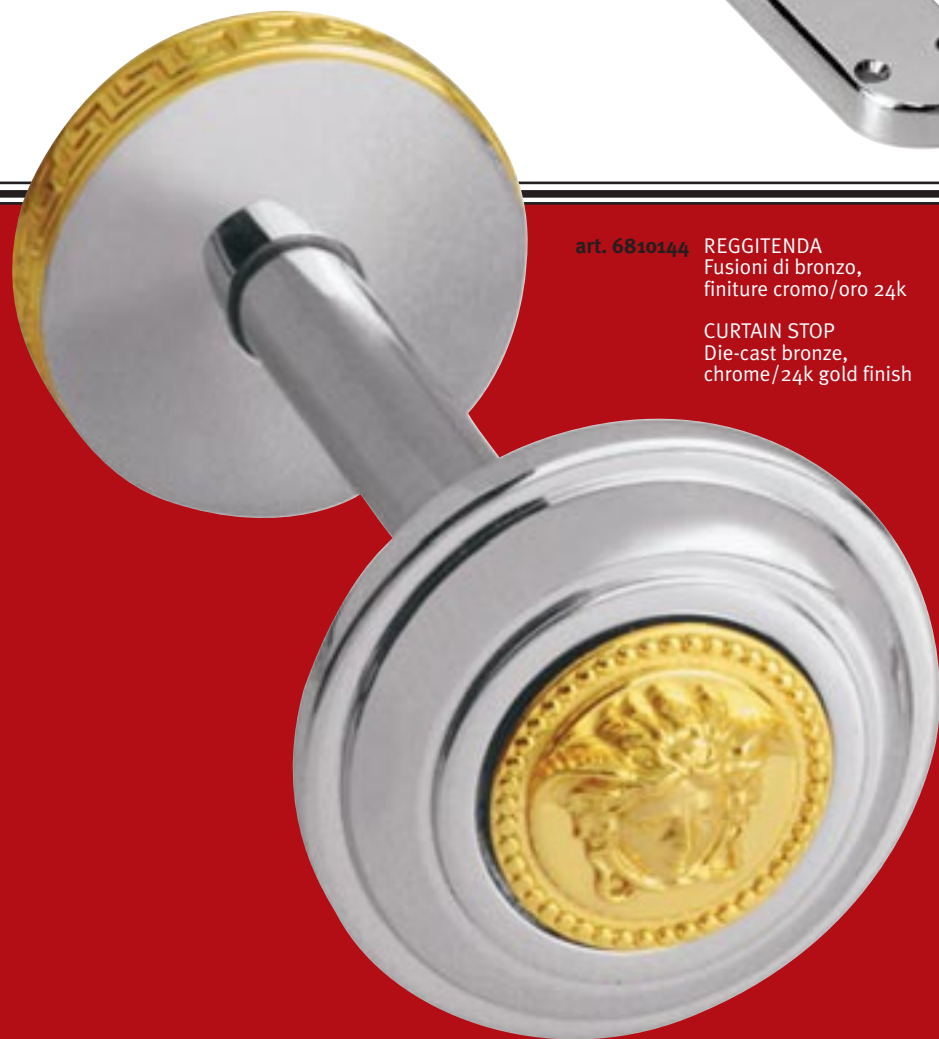

art. 6810144 REGGITENDA
Fusioni di bronzo,
finiture cromo/oro 24k

CURTAIN STOP
Die-cast bronze,
chrome/24k gold finish



art. 6810141
MANIGLIA FINESTRA
Fusioni di bronzo,
dor. oro 24k

WINDOW HANDLE
Die-cast bronze,
24k gold plated



art. 6810140 COPPIA MANIGLIE PER PORTA
Fusioni di bronzo,
finiture cromo/oro 24k
(Rosetta chiave inclusa)

DOOR HANDLES (PAIR)
Die-cast bronze,
chrome/24k gold finish
(Keyhole cover included)



art. 6810139 COPPIA MANIGLIE PER PORTA
Fusioni di bronzo, dor. oro 24k
(Rosetta chiave inclusa)

DOOR HANDLES (PAIR)
Die-cast bronze, 24k gold plated
(Keyhole cover included)



elementi architettonici
architectural elements

VERSACE
CERAMIC DESIGN



Il capitello lavabo qui rappresentato differisce da quello utilizzato negli ambienti Eden del catalogo Versace Ceramic Design. Lo stesso è stato modificato per migliorarne il design e la struttura.

The sink-unit moulding shown here is different from the moulding used in the Eden room-scenes in the Versace Ceramic Design catalogue. The moulding has been modified to improve its design and structural features.

Le chapiteau du lavabo représenté ci-contre diffère de celui utilisé pour Eden du catalogue Versace Ceramic Design. On l'a modifié pour en améliorer le design et la structure.

Das hier abgebildete Waschbecken-Kapitell unterscheidet sich von dem, das in den Raumgestaltungen der Serie Eden im Katalog Versace Ceramic Design verwendet wurde. Es wurde geändert, um sein Design und seine Struktur zu verbessern.

El capitel del lavabo que aquí se muestra es diferente al utilizado en los ambientes Eden del catálogo Versace Ceramic Design. De hecho, se ha modificado a fin de mejorar su diseño y estructura.



art. 6100218 CAPITELLO COLONNA Marmoresina
COLUMN CAPITAL MOULDING Reconstituted marble



art. 6100213 CAPITELLO LAVABO Marmoresina
SINK-UNIT MOULDING Reconstituted marble



art. 6100236/P CORNICE LUCE
Poliuretano, lunghezza 2 m
LIGHT MOULDING
Polyurethane, 2 m long



art. 6100226/P CORNICE FINITURA
Poliuretano, lunghezza 2 m
FINISHING MOULDING
Polyurethane, 2 m long





art. 6810016
FREGIO MEDUSA
Fusioni di bronzo, dor. oro 24K, vetro acidato

MEDUSA MEDALLION
Die-cast bronze, 24K gold plated, acid-etched glass



art. 6810019
COPPIA APPENDIABITI
Fusioni di bronzo, dor. oro 24K, vetro acidato

PAIRED CLOTHES KNOBS
Die-cast bronze, 24K gold plated, acid-etched glass



art. 6810076
COPPIA POMOLI
Fusioni di bronzo, dor. oro 24K, vetro acidato sfaccettato. Senza perno per apertura e chiusura

PAIRED ALL-PURPOSE KNOBS (NO SPINDLE)
Die-cast bronze, 24K gold plated, faceted acid-etched glass



art. 6810017
PORTASAPONE
Fusioni di bronzo, dor. oro 24K, vetro acidato

SOAP DISH
Die-cast bronze, 24K gold plated, acid-etched glass



art. 6810077
PORTASCOPINO DA PARETE
Fusioni di bronzo, dor. oro 24K, inserti in vetro acidato, interno in vetro

WALL BRUSH HOLDER
Die-cast bronze, 24K gold plated, acid-etched glass inserts, glass interior



art. 6810015
COPPA
Fusioni di bronzo, dor. oro 24K, vetro acidato

CUP
Die-cast bronze, 24K gold plated, acid-etched glass



art. 6810010
PORTABICCHIERE
Fusioni di bronzo, dor. oro 24K, bicchiere in vetro acidato

BEAKER HOLDER
Die-cast bronze, 24K gold plated, acid-etched glass



art. 6810013
PORTASAPONE
Fusioni di bronzo, dor. oro 24K, vaschetta interna in vetro acidato

SOAP HOLDER
Die-cast bronze, 24K gold plated, acid-etched glass interior



art. 6810011
SCATOLA
Fusioni di bronzo, dor. oro 24K, vetro acidato

JAR
Die-cast bronze, 24K gold plated, acid-etched glass



art. 6810012
SCATOLA
Fusioni di bronzo, dor. oro 24K, interno e coperchio in vetro acidato

JAR
Die-cast bronze, 24K gold plated, acid-etched glass interior and cover



art. 6810035
FREGIO MEDUSA
Fusioni di bronzo, finitura palladio, vetro acidato

MEDUSA MEDALLION
Die-cast bronze, palladium finish, acid-etched glass



art. 6810038
COPPIA APPENDIABITI
Fusioni di bronzo, finitura palladio, vetro acidato

PAIRED CLOTHES KNOBS
Die-cast bronze, palladium finish, acid-etched glass



art. 6810085
COPPIA POMOLI
Fusioni di bronzo, finitura palladio, vetro acidato sfaccettato. Senza perni per apertura e chiusura

PAIRED ALL-PURPOSE KNOBS (NO SPINDLE)
Die-cast bronze, palladium finish, faceted acid-etched glass



art. 6810036
PORTASAPONE
Fusioni di bronzo, finitura palladio, vetro acidato

SOAP DISH
Die-cast bronze, palladium finish, acid-etched glass



art. 6810078
PORTASCOPINO DA PARETE
Fusioni di bronzo, finitura palladio, inserti in vetro acidato, interno in vetro

WALL BRUSH HOLDER
Die-cast bronze, palladium finish, acid-etched glass inserts, glass interior



art. 6810034
COPPA
Fusioni di bronzo, finitura palladio, vetro acidato

CUP
Die-cast bronze, palladium finish, acid-etched glass



art. 6810029
PORTABICCHIERE
Fusioni di bronzo, finitura palladio, bicchiere in vetro acidato

BEAKER HOLDER
Die-cast bronze, palladium finish, acid-etched glass



art. 6810032
PORTASAPONE
Fusioni di bronzo, finitura palladio, vaschetta interna in vetro acidato

SOAP HOLDER
Die-cast bronze, palladium finish, acid-etched glass interior



art. 6810030
SCATOLA
Fusioni di bronzo, finitura palladio, vetro acidato

JAR
Die-cast bronze, palladium finish, acid-etched glass



art. 6810031
SCATOLA
Fusioni di bronzo, finitura palladio, interno e coperchio in vetro acidato

JAR
Die-cast bronze, palladium finish, acid-etched glass interior and cover



art. 6810016/B
FREGIO MEDUSA
Fusioni di bronzo, dor. oro 24K, vetro blu

MEDUSA MEDALLION
Die-cast bronze, 24K gold plated, blue glass



art. 6810019/B
COPPIA APPENDIABITI
Fusioni di bronzo, dor. oro 24K, vetro blu

PAIRED CLOTHES KNOBS
Die-cast bronze, 24K gold plated, blue glass



art. 6810076/B
COPPIA POMOLI
Fusioni di bronzo, dor. oro 24K, vetro blu. Senza perno per apertura e chiusura

PAIRED ALL-PURPOSE KNOBS (NO SPINDLE)
Die-cast bronze, 24K gold plated, blue glass



art. 6810017/B
PORTASAPONE
Fusioni di bronzo, dor. oro 24K, vetro blu

SOAP DISH
Die-cast bronze, 24K gold plated, blue glass



art. 6810077/B
PORTASCOPINO DA PARETE
Fusioni di bronzo, dor. oro 24K, inserti in vetro blu, interno in vetro

WALL BRUSH HOLDER
Die-cast bronze, 24K gold plated, blue glass interior, glass inserts



art. 6810015/B
COPPA
Fusioni di bronzo, dor. oro 24K, vetro blu

CUP
Die-cast bronze, 24K gold plated, blue glass



art. 6810010/B
PORTABICCHIERE
Fusioni di bronzo, dor. oro 24K, bicchiere in vetro blu

BEAKER HOLDER
Die-cast bronze, 24K gold plated, blue glass



art. 6810013/B
PORTASAPONE
Fusioni di bronzo, dor. oro 24K, vaschetta interna in vetro blu

SOAP HOLDER
Die-cast bronze, 24K gold plated, blue glass interior



art. 6810011/B
SCATOLA
Fusioni di bronzo, dor. oro 24K, vetro blu

JAR
Die-cast bronze, 24K gold plated, blue glass



art. 6810012/B
SCATOLA
Fusioni di bronzo, dor. oro 24K, interno e coperchio in vetro blu

JAR
Die-cast bronze, 24K gold plated, blue glass interior and cover



art. 6810035/B
FREGIO MEDUSA
Fusioni di bronzo, finitura palladio, vetro blu

MEDUSA MEDALLION
Die-cast bronze, palladium finish, blue glass



art. 6810038/B
COPPIA APPENDIABITI
Fusioni di bronzo, finitura palladio, vetro blu

PAIRED CLOTHES KNOBS
Die-cast bronze, palladium finish, blue glass



art. 6810085/B
COPPIA POMOLI
Fusioni di bronzo, finitura palladio, vetro blu. Senza perno per apertura e chiusura

PAIRED ALL-PURPOSE KNOBS (NO SPINDLE)
Die-cast bronze, palladium finish, blue glass



art. 6810036/B
PORTASAPONE
Fusioni di bronzo, finitura palladio, vetro blu

SOAP DISH
Die-cast bronze, palladium finish, blue glass



art. 6810078/B
PORTASCOPINO DA PARETE
Fusioni di bronzo, finitura palladio, inserti in vetro blu, interno in vetro

WALL BRUSH HOLDER
Die-cast bronze, palladium finish, blue glass interior, glass inserts



art. 6810034/B
COPPA
Fusioni di bronzo, finitura palladio, vetro blu

CUP
Die-cast bronze, palladium finish, blue glass



art. 6810029/B
PORTABICCHIERE
Fusioni di bronzo, finitura palladio, bicchiere in vetro blu

BEAKER HOLDER
Die-cast bronze, palladium finish, blue glass



art. 6810032/B
PORTASAPONE
Fusioni di bronzo, finitura palladio, vaschetta interna in vetro blu

SOAP HOLDER
Die-cast bronze, palladium finish, blue glass interior



art. 6810030/B
SCATOLA
Fusioni di bronzo, finitura palladio, vetro blu

JAR
Die-cast bronze, palladium finish, blue glass



art. 6810031/B
SCATOLA
Fusioni di bronzo, finitura palladio, interno e coperchio in vetro blu

JAR
Die-cast bronze, palladium finish, blue glass interior and cover

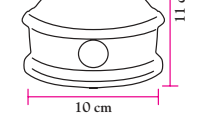
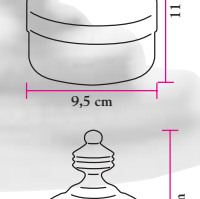
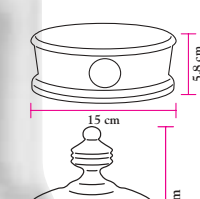
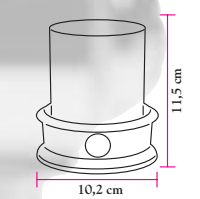
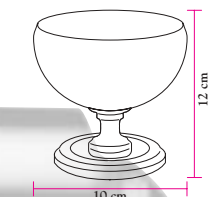
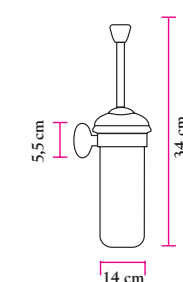
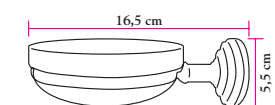
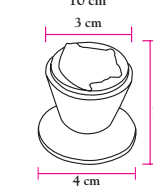
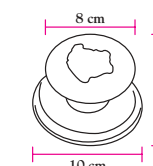
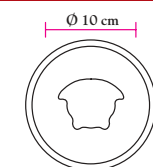

ARTICOLI IN BLUE GLASS ARE ONLY AVAILABLE ON REQUEST
Los artículos con cristal de color azul únicamente están disponibles bajo pedido

Die Artikel mit blauem Glas sind ausschließlich auf Anfrage erhältlich

GLI ARTICOLI CON VETRO BLU SONO DISPONIBILI ESCLUSIVAMENTE SU RICHIESTA
Les articles avec du verre bleu sont exclusivement disponibles sur demande



art. 6810018
PORTAROTOLO
Fusioni di bronzo, dor. oro 24K
PAPER ROLL HOLDER
Die-cast bronze, 24K gold plated



art. 6810037
PORTAROTOLO
Fusioni di bronzo, finitura palladio
PAPER ROLL HOLDER
Die-cast bronze, palladium finish

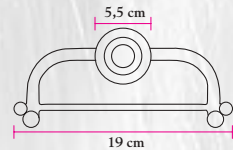

art. 6810014
SCATOLA PORTA KLEENEX
Fusioni di bronzo, dor. oro 24K
NAPKIN DISPENSER
Die-cast bronze, 24K gold plated



art. 6810033
SCATOLA PORTA KLEENEX
Fusioni di bronzo, finitura palladio
NAPKIN DISPENSER
Die-cast bronze, palladium finish

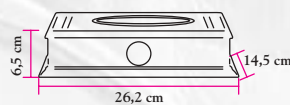

art. 6810079
PORTA ASCIUGAMANI
AD ANELLO
Fusioni di bronzo,
dor. oro 24K
RING TOWEL HOLDER
Die-cast bronze,
24K gold plated



art. 6810080
PORTA ASCIUGAMANI
AD ANELLO
Fusioni di bronzo,
finitura palladio
RING TOWEL HOLDER
Die-cast bronze,
palladium finish

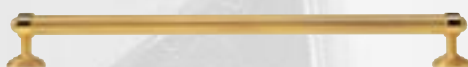
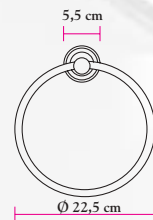

art. 6810009
PORTA ASCIUGAMANI
Fusioni di bronzo, dor. oro 24K, lunghezza 60 cm
TOWEL HOLDER
Die-cast bronze, 24K gold plated, width 60 cm



art. 6810028
PORTA ASCIUGAMANI
Fusioni di bronzo, finitura palladio, lunghezza 60 cm
TOWEL HOLDER
Die-cast bronze, palladium finish, width 60 cm

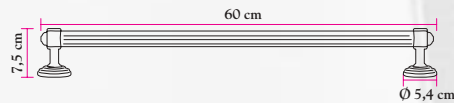

art. 6810008
PORTA ASCIUGAMANI
Fusioni di bronzo, dor. oro 24K, lunghezza 45 cm
TOWEL HOLDER
Die-cast bronze, 24K gold plated, width 45 cm



art. 6810027
PORTA ASCIUGAMANI
Fusioni di bronzo, finitura palladio, lunghezza 45 cm
TOWEL HOLDER
Die-cast bronze, palladium finish, width 45 cm

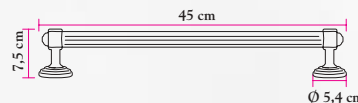

art. 6810007
PORTA ASCIUGAMANI
Fusioni di bronzo, dor. oro 24K, lunghezza 30 cm
TOWEL HOLDER
Die-cast bronze, 24K gold plated, width 30 cm



art. 6810026
PORTA ASCIUGAMANI
Fusioni di bronzo, finitura palladio, lunghezza 30 cm
TOWEL HOLDER
Die-cast bronze, palladium finish, width 30 cm

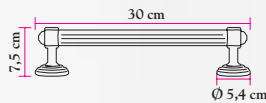

art. 6810081
MENSOLA
Cristallo, fusioni di bronzo,
dor. oro 24K,
lunghezza 60 cm

SHELF
Crystal, die-cast bronze,
24K gold plated,
width 60 cm



art. 6810084
MENSOLA
Cristallo, fusioni di bronzo,
finitura palladio,
lunghezza 60 cm

SHELF
Crystal, die-cast bronze,
palladium finish,
width 60 cm

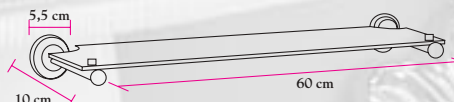

art. 6810094
MENSOLA
Cristallo, fusioni di bronzo,
dor. oro 24K,
lunghezza 45 cm

SHELF
Crystal, die-cast bronze,
24K gold plated,
width 45 cm



art. 6810096
MENSOLA
Cristallo, fusioni di bronzo,
finitura palladio,
lunghezza 45 cm

SHELF
Crystal, die-cast bronze,
palladium finish,
width 45 cm

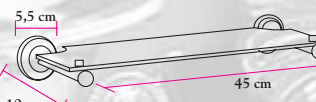

art. 6810095
MENSOLA
Cristallo, fusioni di bronzo,
dor. oro 24K,
lunghezza 30 cm

SHELF
Crystal, die-cast bronze,
24K gold plated,
width 30 cm



art. 6810097
MENSOLA
Cristallo, fusioni di bronzo,
finitura palladio,
lunghezza 30 cm

SHELF
Crystal, die-cast bronze,
palladium finish,
width 30 cm

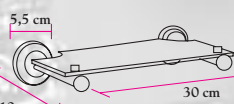

art. 6810056
BATTERIA LAVABO A TRE FORI
Fusioni di bronzo, dor. oro 24K
Pezzi per il montaggio inclusi
THREE-HOLE WASHBASIN SET
Die-cast bronze, 24K gold plated
Assembly parts included



art. 6810039
BATTERIA LAVABO A TRE FORI
Fusioni di bronzo,
finiture cromo/oro 24k
Pezzi per il montaggio inclusi
THREE-HOLE WASHBASIN SET
Die-cast bronze,
chrome/24k gold finish
Assembly parts included

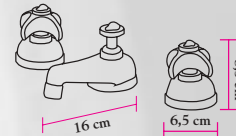

art. 6810055
BATTERIA BIDET A TRE FORI
Fusioni di bronzo, dor. oro 24K
Pezzi per il montaggio inclusi
THREE-HOLE BIDET SET
Die-cast bronze, 24K gold plated
Assembly parts included

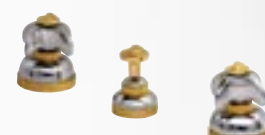

art. 6810092
MONOFORO BIDET
Fusioni di bronzo, finiture cromo/oro 24k
Pezzi per il montaggio inclusi
SINGLE-HOLE BIDET SET
Die-cast bronze, chrome/24k gold finish
Assembly parts included

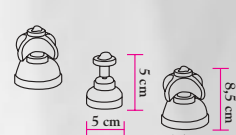

art. 6810054
MONOFORO BIDET
Fusioni di bronzo, dor. oro 24K
Pezzi per il montaggio inclusi
SINGLE-HOLE BIDET SET
Die-cast bronze, 24K gold plated
Assembly parts included



art. 6810093
BRACCIO DOCCIA
Fusioni di bronzo,
finiture cromo/oro 24k
SHOWER ARM
Die-cast bronze,
chrome/24k gold finish



art. 6810052
BRACCIO DOCCIA
Fusioni di bronzo,
dor. oro 24K
SHOWER ARM
Die-cast bronze,
24K gold plated



art. 6810065
MISCELATORE TERMOSTATICO
A DUE USCITE
Fusioni di bronzo, dor. oro 24K
TWO-OUTLET THERMOSTATIC MIXER
Die-cast bronze, 24K gold plated

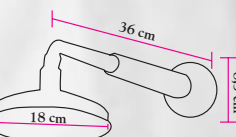

art. 6810053
MISCELATORE TERMOSTATICO
A DUE USCITE
Fusioni di bronzo, dor. oro 24K
TWO-OUTLET THERMOSTATIC MIXER
Die-cast bronze, 24K gold plated



art. 6810099
RUBINETTO SINGOLO
Fusioni di bronzo, finiture cromo/oro 24k
SINGLE FAUCET
Die-cast bronze, chrome/24k gold finish

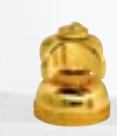

art. 6810098
RUBINETTO SINGOLO
Fusioni di bronzo, dor. oro 24K
SINGLE FAUCET
Die-cast bronze, 24K gold plated.



art. 6810041
GRUPPO VASCA AD INCASSO
CON DUPLEX E COLONNA
EROGATORE AL TROPPO PIENO
Fusioni di bronzo,
finiture cromo/oro 24k
Pezzi per il montaggio inclusi
DROP-IN BATHTUB SET WITH
SHOWER DUPLEX UNIT AND
FAUCET COLUMN OVERFLOW
Die-cast bronze, 24K gold plated
Assembly parts included



art. 6810058
GRUPPO VASCA AD INCASSO
CON DUPLEX E COLONNA
EROGATORE AL TROPPO PIENO
Fusioni di bronzo, dor. oro 24K
Pezzi per il montaggio inclusi



art. 6810094
GRUPPO VASCA ESTERNO
Fusioni di bronzo, dor. oro 24K
Pezzi per il montaggio inclusi
OUTSIDE BATHTUB UNIT
Die-cast bronze,
24K gold plated
Assembly parts included

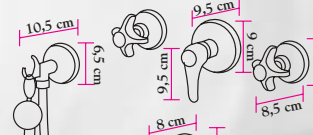

art. 6810059
GRUPPO VASCA ESTERNO
Fusioni di bronzo, dor. oro 24K
Pezzi per il montaggio inclusi
OUTSIDE BATHTUB UNIT
Die-cast bronze,
24K gold plated
Assembly parts included



art. 6810042
GRUPPO VASCA ESTERNO
Fusioni di bronzo,
finiture cromo/oro 24k
Pezzi per il montaggio inclusi
OUTSIDE BATHTUB UNIT
Die-cast bronze,
chrome/24k gold finish
Assembly parts included





art. 6810057
GRUPPO BORDO VASCA
QUATTRO FORI CON DOCCIA
ESTRAIBILE E COLONNA
EROGATORE AL TROPPO PIENO
Fusioni di bronzo, dor.oro 24k
(Pezzi per il montaggio inclusi)

FOUR-HOLE BATHTUB SIDE SET
WITH PULL-OUT SHOWER HOSE
AND FAUCET COLUMN OVERFLOW UNIT
Die-cast bronze, 24K gold plated
(Assembly parts included)



art. 6810040
GRUPPO BORDO VASCA
QUATTRO FORI CON DOCCIA
ESTRAIBILE E COLONNA
EROGATORE AL TROPPO PIENO
Fusioni di bronzo, finiture cromo/oro 24k
(Pezzi per il montaggio inclusi)

FOUR-HOLE BATHTUB SIDE SET
WITH PULL-OUT SHOWER HOSE
AND FAUCET COLUMN OVERFLOW UNIT
Die-cast bronze, chrome/24k gold finish
(Assembly parts included)

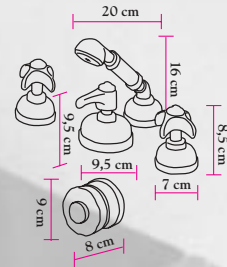

art. 6810126
DUPLIX
Fusioni di bronzo,
dor. oro 24K

DUPLIX UNIT
Die-cast bronze,
24K gold plated



art. 6810119
DUPLIX
Fusioni di bronzo,
finiture cromo/oro 24k

DUPLIX UNIT
Die-cast bronze,
chrome/24k gold finish

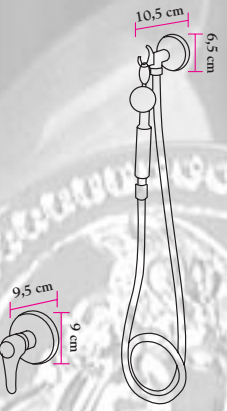

art. 6810123
DEVIATORE
Fusioni di bronzo,
dor. oro 24K

FLOW DIVERTER
Die-cast bronze,
24K gold plated



art. 6810122
DEVIATORE
Fusioni di bronzo,
finiture cromo/oro 24k

FLOW DIVERTER
Die-cast bronze,
chrome/24k gold finish

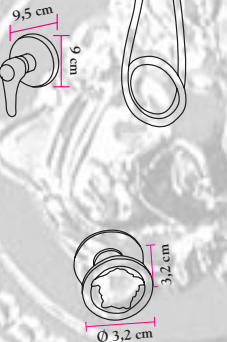

art. 6810147
COPPIA POMOLI
Fusioni di bronzo,
dor. oro 24k, cm 3,2.
Senza perno per apertura e chiusura

PAIRED ALLPURPOSE KNOBS
(NO SPINDLE)
Die-cast bronze,
24K gold plated, 3.2 cm



art. 6810148
COPPIA POMOLI
Fusioni di bronzo,
finiture cromo cm 3,2.
Senza perno per apertura e chiusura

PAIRED ALLPURPOSE KNOBS
(NO SPINDLE)
Die-cast bronze,
chrome finish, 3.2 cm



art. 6810145
COPPIA POMOLI
Fusioni di bronzo,
dor. oro 24k, cm 2,6.
Senza perno per apertura e chiusura

PAIRED ALLPURPOSE KNOBS
(NO SPINDLE)
Die-cast bronze,
24K gold plated, 2.6 cm



art. 6810146
COPPIA POMOLI
Fusioni di bronzo,
finiture cromo cm 2,6.
Senza perno per apertura e chiusura

PAIRED ALLPURPOSE KNOBS
(NO SPINDLE)
Die-cast bronze,
chrome finish, 2.6 cm



art. 6810105
PORTA SAPONE LIQUIDO DA APPOGGIO
Fusioni di bronzo, dor. oro 24k

LIQUID SOAP DISPENSER
Die-cast bronze, 24K gold plated



art. 6810106
PORTA SAPONE LIQUIDO DA APPOGGIO
Fusioni di bronzo, finiture cromo/oro 24k

LIQUID SOAP DISPENSER
Die-cast bronze, chrome/24k gold finish



art. 6810109
PORTA SAPONE LIQUIDO DA MURO
Fusioni di bronzo, dor. oro 24k

WALL-MOUNTED LIQUID SOAP DISPENSER
Die-cast bronze, 24K gold plated



art. 6810110
PORTA SAPONE LIQUIDO DA MURO
Fusioni di bronzo, finiture cromo/oro 24k

WALL-MOUNTED LIQUID SOAP DISPENSER
Die-cast bronze,chrome/24k gold finish

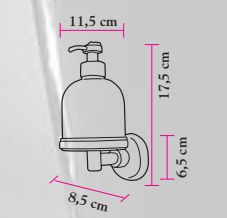

art. 6810050
PORTASCOPINO
Fusioni di bronzo,
dor. oro 24k

BRUSH HOLDER
Die-cast bronze,
24K gold plated



art. 6810064
PORTASCOPINO
Fusioni di bronzo,
finiture cromo/oro 24k

BRUSH HOLDER
Die-cast bronze,
chrome/24k gold finish

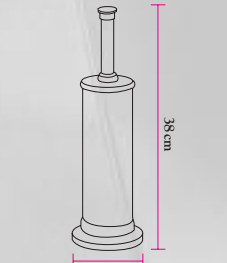

art. 6810043
PORTASAPONE A PARETE
Fusioni di bronzo,
dor. oro 24k, vetro acidato

WALL SOAP HOLDER
Die-cast bronze,
24K gold plated, acid-etched glass



art. 6810060
PORTASAPONE A PARETE
Fusioni di bronzo,
finiture cromo/oro 24k, vetro acidato

WALL SOAP HOLDER
Die-cast bronze,
chrome/24k gold finish,
acid-etched glass

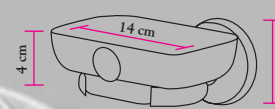

art. 6810045
PORTABICCHIERE DA PARETE
Fusioni di bronzo,
dor. oro 24k, vetro acidato

WALL CUP HOLDER
Die-cast bronze, 24K gold plated,
acid-etched glass



art. 6810062
PORTABICCHIERE DA PARETE
Fusioni di bronzo,
finiture cromo/oro 24k, vetro acidato

WALL CUP HOLDER
Die-cast bronze,
chrome/24k gold finish,
acid-etched glass

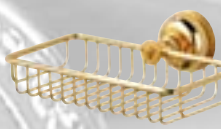
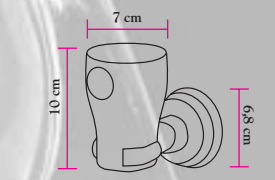

art. 6810044
PORTASPUGNA
Fusioni di bronzo,
dor. oro 24k

SPONGE HOLDER
Die-cast bronze,
24K gold plated

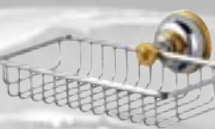

art. 6810061
PORTASPUGNA
Fusioni di bronzo,
finiture cromo/oro 24k

SPONGE HOLDER
Die-cast bronze,
chrome/24k gold finish

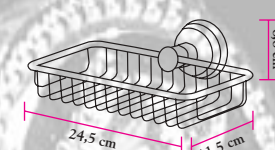

art. 6810051
PORTA ABITI
Fusioni di bronzo, dor. oro 24k

CLOTHES HANGER
Die-cast bronze, 24K gold plated



art. 6810087
PORTA ABITI
Fusioni di bronzo, finiture cromo/oro 24k

CLOTHES HANGER
Die-cast bronze, chrome/24k gold finish



art. 6810047
PORTA ASCIUGAMANI
Fusioni di bronzo,
dor. oro 24k,
lunghezza 40 cm

TOWEL HOLDER
Die-cast bronze,
24K gold plated,
width 40 cm



art. 6810063
PORTA ASCIUGAMANI
Fusioni di bronzo,
finiture cromo/oro 24k,
lunghezza 40 cm

TOWEL HOLDER
Die-cast bronze,
chrome/24k gold finish,
width 40 cm

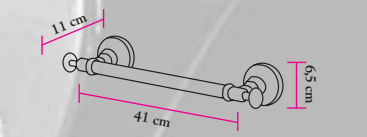

art. 6810048
PORTA ASCIUGAMANI
Fusioni di bronzo,
dor. oro 24k,
lunghezza 60 cm

TOWEL HOLDER
Die-cast bronze,
24K gold plated,
width 60 cm



art. 6810090
PORTA ASCIUGAMANI
Fusioni di bronzo,
finiture cromo/oro 24k ,
lunghezza 60 cm

TOWEL HOLDER
Die-cast bronze,
chrome/24k gold finish,
width 60 cm

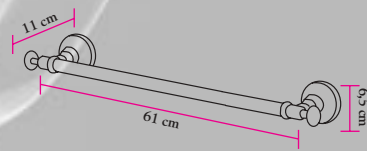

art. 6810046
PORTA ASCIUGAMANI AD ANELLO
Fusioni di bronzo,
dor. oro 24k

RING TOWEL HOLDER
Die-cast bronze, 24K gold plated



art. 6810089
PORTA ASCIUGAMANI AD ANELLO
Fusioni di bronzo, finiture cromo/oro 24k

RING TOWEL HOLDER
Die-cast bronze, chrome/24k gold finish

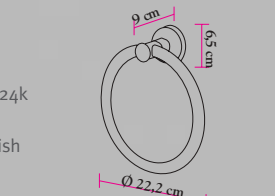

art. 6810049
PORTAROTOLO
Fusioni di bronzo, dor. oro 24k

PAPER ROLL HOLDER
Die-cast bronze, 24K gold plated



art. 6810088
PORTAROTOLO
Fusioni di bronzo, finiture cromo/oro 24k

PAPER ROLL HOLDER
Die-cast bronze, chrome/24k gold finish

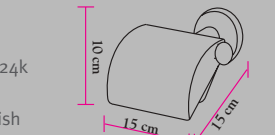



art. 6810023/O (Europa)
art. 6810023/E (USA-Australia)
APPLIQUE CONCHIGLIA
Fusioni di bronzo,
finitura palladio
SHELL WALL LAMP
Die-cast bronze,
palladium finish

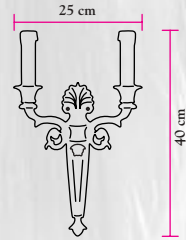

art. 6810083/O (Europa)
art. 6810083/E (USA-Australia)
APPLIQUE SNODO
Fusioni di bronzo,
finitura palladio
ARTICULATED WALL LAMP
Die-cast bronze, palladium finish

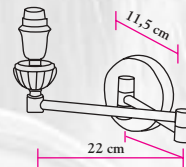

art. 6810021/O (Europa)
art. 6810021/E (USA-Australia)
APPLIQUE
Fusioni di bronzo,
finitura palladio
WALL LAMP
Die-cast bronze,
palladium finish

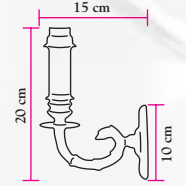

art. 6810022/O (Europa)
art. 6810022/E (USA-Australia)
APPLIQUE CONCHIGLIA
Fusioni di bronzo,
dor. oro 24K, h 40 cm
SHELL WALL LAMP
Die-cast bronze,
24K gold plated, h 40 cm

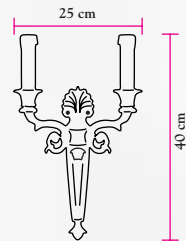

art. 6810003/O (Europa)
art. 6810003/E (USA-Australia)
APPLIQUE
Fusioni di bronzo,
dor. oro 24K,
legno laccato nero,
h 53 cm
WALL LAMP
Die-cast bronze,
24K gold plated,
black lacquered wood, h 53 cm

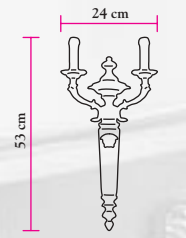

art. 6810002/O (Europa)
art. 6810002/E (USA-Australia)
APPLIQUE
Fusioni di bronzo,
dor. oro 24K,
h 53 cm
WALL LAMP
Die-cast bronze,
24K gold plated,
h 53 cm

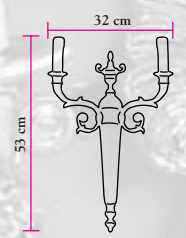

art. 6810082/O (Europa)
art. 6810082/E (USA-Australia)
APPLIQUE SNODO
Fusioni di bronzo, dor. oro 24K
ARTICULATED WALL LAMP
Die-cast bronze, 24K gold plated

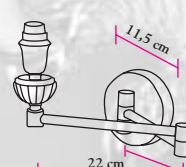

art. 6810001/O (Europa)
art. 6810001/E (USA-Australia)
APPLIQUE
Fusioni di bronzo, dor. oro 24K
WALL LAMP
Die-cast bronze, 24K gold plated

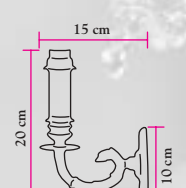

art. 6810072/O
PARALUME
Tessuto Bemberg,
finitura argento
(per applique doppia)
LAMP SHADE
Bemberg fabric, silver trim
(for double wall lamp)

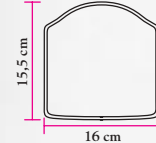

art. 6810025/O
PARALUME
Tessuto Bemberg,
finitura argento
(per applique singola)
LAMP SHADE
Bemberg fabric, silver trim
(for single wall lamp)

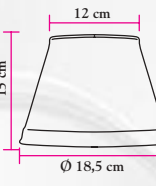

art. 6810072/A
PARALUME
Tessuto Bemberg,
finitura argento
(per applique singola)
LAMP SHADE
Bemberg fabric, silver trim
(for single wall lamp)

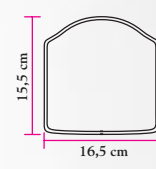

art. 6810005/O
PARALUME
Seta decoro barocchino, fondo azzurro
(per applique doppia)
LAMP SHADE
Silk barocchino decor, blue
background **(for double wall lamp)**

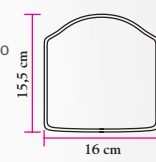

art. 6810006/O
PARALUME
Seta decoro meduse oro, finitura
nera **(per applique doppia)**
LAMP SHADE
Silk gold medusa decor, black trim
(for double wall lamp)

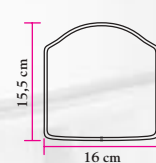

art. 6810004/O
PARALUME
Seta decoro barocchino, fondo oro
(per applique singola)
LAMP SHADE
Silk barocchino decor, gold
background **(for single wall lamp)**

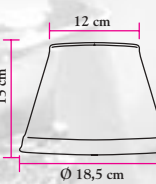

art. 6810020/O
PARALUME
Tessuto Bemberg, finitura oro
(per applique singola)
LAMP SHADE
Bemberg fabric, gold trim
(for single wall lamp)

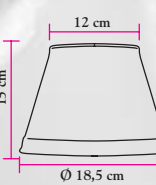

art. 6810005/A
PARALUME
Seta decoro barocchino, fondo
azzurro **(per applique singola)**
LAMP SHADE
Silk barocchino decor, blue
background **(for single wall lamp)**

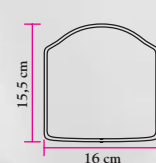

art. 6810006/A
PARALUME
Seta decoro meduse oro, finitura nera
(per applique singola)
LAMP SHADE
Silk gold medusa decor, black trim
(for single wall lamp)

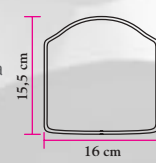

art. 6810143
REGGITENDA
Fusioni di bronzo, dor. oro 24k
CURTAIN STOP
Die-cast bronze, 24K gold plated



art. 6810144
REGGITENDA
Fusioni di bronzo, finiture cromo/oro 24k
CURTAIN STOP
Die-cast bronze, chrome/24k gold finish

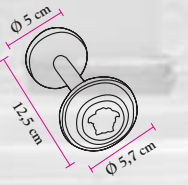

art. 6810141
MANIGLIA FINESTRA
Fusioni di bronzo, dor. oro 24k
WINDOW HANDLE
Die-cast bronze, 24K gold plated



art. 6810142
MANIGLIA FINESTRA
Fusioni di bronzo, finiture cromo/oro 24k
WINDOW HANDLE
Die-cast bronze, chrome/24k gold finish

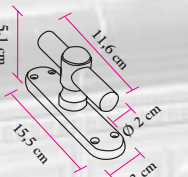

art. 6810139
COPPIA MANIGLIE PER PORTA
Fusioni di bronzo, dor. oro 24k
(Rosetta chiave inclusa)
DOOR HANDLES (PAIR)
Die-cast bronze, 24K gold plated
(Keyhole cover included)



art. 6810140
COPPIA MANIGLIE PER PORTA
Fusioni di bronzo, finiture cromo/oro 24k
(Rosetta chiave inclusa)
DOOR HANDLES (PAIR)
Die-cast bronze, chrome/24k gold finish
(Keyhole cover included)

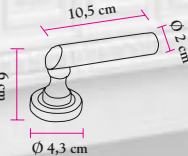

ELEMENTI ARCHITETTONICI



art. 6100213
CAPITELLO LAVABO
Marmoresina
SINK-UNIT MOULDING
Reconstituted marble

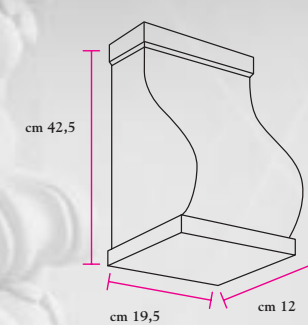

art. 6100218
CAPITELLO COLONNA
Marmoresina
COLUMN CAPITAL
MOULDING
Reconstituted marble

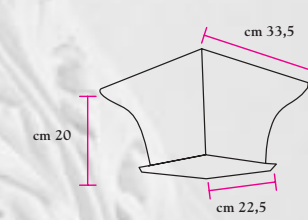

art. 6100236/P
CORNICE LUCE
Poliuretano, lunghezza 2 m
LIGHT MOULDING
Polyurethane, 2 m long

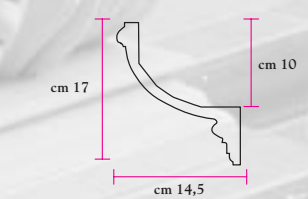

art. 6100226/P
CORNICE FINITURA
Poliuretano, lunghezza 2 m
FINISHING MOULDING
Polyurethane, 2 m long

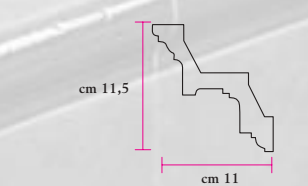

VERSACE

CERAMIC DESIGN

produttore autorizzato
ceramica, accessori e complementi d'arredo bagno



Spezzano, MO (Italy)
tel +39.0536.849611 • fax +39.0536.849856
www.gardeniaorchidea.com • www.versacecd.com
e-mail: info@versacecd.com

"All marks created by GIANNI VERSACE S.p.A. Milano, Italy - Trade marks rights reserved to GIANNI VERSACE S.p.A. Milano and its successors in title".

Nessuna iniziativa pubblicitaria potrà essere intrapresa se non previamente autorizzata volta per volta e per iscritto da GIANNI VERSACE S.p.A.

No advertising initiative can be undertaken without previous written authorization given each time by GIANNI VERSACE S.p.A.

I colori possono risultare falsati dai procedimenti litografici.
The colours could be altered by the lithographic printing process.
Les couleurs des produits pourraient s'avérer différentes de celles reproduites.
Durch die Lithographie können farbliche Täuschungen entstehen.
Los colores pueden resultar falseados por los procedimientos litográficos.



VERSACE
CERAMIC DESIGN

PRODUTTORE AUTORIZZATO • AUTHORIZED MANUFACTURER



CERAMICHE
**GARDENIA
ORCHIDEA**

COD.6000427